

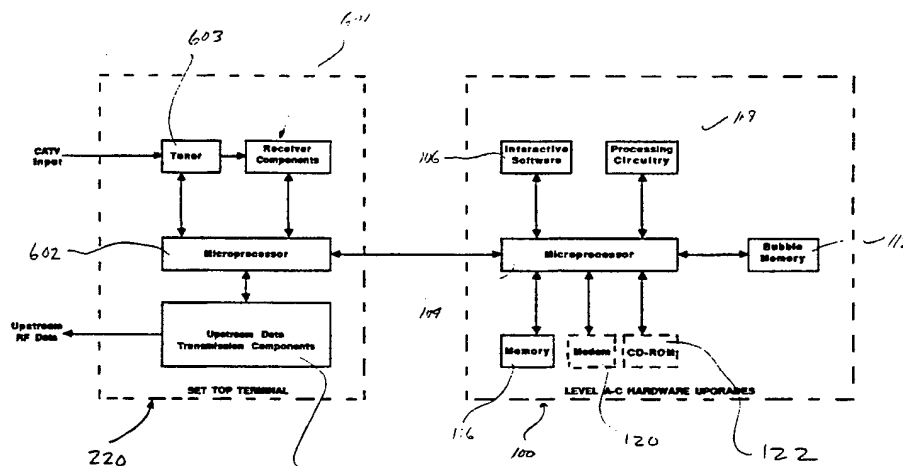

INTERNATIONAL APPLICATION PUBLISHED UNDER THE PATENT COOPERATION TREATY (PCT)

<p>(51) International Patent Classification <sup>5</sup> : H04N 7/16, 7/173</p>	<p>A1</p>	<p>(11) International Publication Number: <b>WO 94/13107</b> (43) International Publication Date: 9 June 1994 (09.06.94)</p>
<p>(21) International Application Number: PCT/US93/11606 (22) International Filing Date: 2 December 1993 (02.12.93) (30) Priority Data: 07/991,074 2 December 1992 (02.12.92) US (71) Applicant: DISCOVERY COMMUNICATIONS, INC. [US/US]; 7700 Wisconsin Avenue, Bethesda, MD 20814-3522 (US). (72) Inventors: HENDRICKS, John, S.; 8723 Persimmon Tree Road, Potomac, MD 20854 (US). BONNER, Alfred, E.; 8300 Bradley Boulevard, Bethesda, MD 20817 (US). WUNDERLICH, Richard, E.; 290 Sweet Briar Court, Alpharetta, GA 30201 (US). BERKOBIN, Eric, C.; 108 Hillview Court, Woodstock, GA 30188 (US). (74) Agents: NOTO, Aldo; Dorsey &amp; Whitney, 1330 Connecticut Avenue, N.W., Suite 200, Washington, DC 20036 (US) et al.</p>	<p>(81) Designated States: AT, AU, BB, BG, BR, BY, CA, CH, CZ, DE, DK, ES, FI, GB, HU, JP, KP, KR, KZ, LK, LU, LV, MG, MN, MW, NL, NO, NZ, PL, PT, RO, RU, SD, SE, SK, UA, VN, European patent (AT, BE, CH, DE, DK, ES, FR, GB, GR, IE, IT, LU, MC, NL, PT, SE), OAPI patent (BF, BJ, CF, CG, CI, CM, GA, GN, ML, MR, NE, SN, TD, TG).</p> <p><b>Published</b> <i>With international search report. Before the expiration of the time limit for amending the claims and to be republished in the event of the receipt of amendments.</i></p>	

(54) Title: ADVANCED SET TOP TERMINAL FOR CABLE TELEVISION DELIVERY SYSTEMS



**(57) Abstract**

A novel advanced set top terminal capable of digital decompression, menu generation, interactivity and other advanced functional capabilities for use in a television program delivery system (200) is described. The invention relates to methods and apparatus for upgrading existing set top terminals (220) to provide menu generation capability and advanced functional capabilities. The invention is particularly useful in television program delivery systems (200) with hundreds of channels of programming, providing (i) menu driven program selection through the addition of an upgrade module (300) or menu generation card and (ii) advanced functional capabilities using a set of hardware upgrades (e.g. 130) and/or an expansion card. Specifically, the invention is an upgradeable system that supports advanced set top functionality through the use of internal software, hardware upgrades, an upgrade module and/or expansion cards. The upgraded hardware generally includes a microprocessor, various input/output ports (e.g., 308), processing circuitry (e.g., 108) and memory (e.g., 116). The invention results in an upgraded set top terminal that supports: menu generation; picture-on-picture displays; program catalogue services; interactive services; telephone caller identification; digital audio reception; VCR control; HDTV reception; and backyard satellite system interoperability, among other features and capabilities.

**FOR THE PURPOSES OF INFORMATION ONLY**

Codes used to identify States party to the PCT on the front pages of pamphlets publishing international applications under the PCT.

AT	Austria	GB	United Kingdom	MR	Mauritania
AU	Australia	GE	Georgia	MW	Malawi
BB	Barbados	GN	Guinea	NE	Niger
BE	Belgium	GR	Greece	NL	Netherlands
BF	Burkina Faso	HU	Hungary	NO	Norway
BG	Bulgaria	IE	Ireland	NZ	New Zealand
BJ	Benin	IT	Italy	PL	Poland
BR	Brazil	JP	Japan	PT	Portugal
BY	Belarus	KE	Kenya	RO	Romania
CA	Canada	KG	Kyrgyzstan	RU	Russian Federation
CF	Central African Republic	KP	Democratic People's Republic of Korea	SD	Sudan
CG	Congo	KR	Republic of Korea	SE	Sweden
CH	Switzerland	KZ	Kazakhstan	SI	Slovenia
CI	Côte d'Ivoire	LI	Liechtenstein	SK	Slovakia
CN	China	LK	Sri Lanka	SN	Senegal
CS	Czechoslovakia	LU	Luxembourg	TD	Chad
CZ	Czech Republic	LV	Larvia	TG	Togo
DE	Germany	MC	Monaco	TJ	Tajikistan
DK	Denmark	MD	Republic of Moldova	TT	Trinidad and Tobago
ES	Spain	MG	Madagascar	UA	Ukraine
FI	Finland	ML	Mali	US	United States of America
FR	France	MN	Mongolia	UZ	Uzbekistan
GA	Gabon			VN	Viet Nam

ADVANCED SET TOP TERMINAL FOR CABLE TELEVISION DELIVERY SYSTEMSRELATED APPLICATIONS

This application is a continuation-in-part of application Serial Number 07/991,074 filed December 9, 1992 entitled TELEVISION PROGRAM PACKAGING AND DELIVERY SYSTEM WITH MENU DRIVEN SUBSCRIBER ACCESS. The following other continuation-in-part applications, also based on the above-referenced patent application, are incorporated herein by reference:

5 Ser. No. \_\_\_\_\_, entitled REPROGRAMMABLE  
10 TERMINAL FOR SUGGESTING PROGRAMS OFFERED ON A  
TELEVISION PROGRAM DELIVERY SYSTEM, filed on  
December \_\_\_\_, 1993;

Ser. No. \_\_\_\_\_, entitled NETWORK CONTROLLER FOR  
15 CABLE TELEVISION DELIVERY SYSTEMS, filed on December  
\_\_\_\_, 1993;

Ser. No. \_\_\_\_\_, entitled AN OPERATIONS CENTER  
FOR A TELEVISION PROGRAM PACKAGING AND DELIVERY  
SYSTEM, filed on December \_\_\_\_, 1993;

Ser. No. \_\_\_\_\_, entitled SET TOP TERMINAL FOR  
20 CABLE TELEVISION DELIVERY SYSTEMS, filed on December  
\_\_\_\_, 1993;

Ser. No. \_\_\_\_\_, entitled DIGITAL CABLE HEADEND  
FOR CABLE TELEVISION DELIVERY SYSTEM, filed on  
December \_\_\_\_, 1993.

25

TECHNICAL FIELD

The invention relates to television entertainment systems for providing television programming to consumer homes. More particularly, the invention relates to a set top terminal for use with a program delivery system with menu selection of programs.

30

**BACKGROUND OF THE INVENTION**

Advances in television entertainment have been primarily driven by breakthroughs in technology. In 1939, advances on Vladimir Zworykin's picture tube provided the stimulus for NBC to begin its first regular broadcasts. In 1975, advances in satellite technology provided consumers with increased programming to homes.

Many of these technology breakthroughs have produced inconvenient systems for consumers. One example is the ubiquitous three remote control home, having a separate and unique remote control for the TV, cable box and VCR. More recently, technology has provided cable users in certain parts of the country with 100 channels of programming. This increased program capacity is beyond the ability of many consumers to use effectively. No method of managing the program choices has been provided to consumers.

Consumers are demanding that future advances in television entertainment, particularly programs and program choices, be presented to the consumer in a user friendly manner. Consumer preferences, instead of technological breakthroughs, will drive the television entertainment market for at least the next 20 years. As computer vendors have experienced a switch from marketing new technology in computer hardware to marketing better useability, interfaces and service, the television entertainment industry will also experience a switch from new technology driving the market to consumer useability driving the market.

Consumers want products incorporating new technology that are useful, and will no longer purchase new technology for the sake of novelty or status. Technological advances in sophisticated hardware are beginning to surpass the capability of the average consumer to use the new

technology. Careful engineering must be done to make entertainment products incorporating new technology useful and desired by consumers.

5 In order for new television entertainment products to be successful, the products must satisfy consumer demands. TV consumers wish to go from limited viewing choices to a variety of choices, from no control of programming to complete control. Consumers wish to advance from cumbersome and inconvenient television to easy and  
10 convenient television and keep costs down. Consumers do not wish to pay for one hundred channels when due to lack of programming information, they seldom, if ever, watch programming on many of these channels.

15 The concepts of interactive television, high definition television and 300 channel cable systems in consumer homes will not sell if they are not packaged, delivered and presented in a useable fashion to consumers. The problem is that TV programming is not being delivered and presented to consumers in a user friendly manner.

20 Consumers are already being bombarded with programming options, numerous "free" cable channels, subscription cable channels and pay-per-view choices. Any further increase in TV entertainment choices, without a user friendly presentation and approach, will likely bewilder  
25 viewers with a mind-numbing array of choices.

The TV industry has traditionally marketed and sold its programs to consumers in bulk, such as continuous feed broadcast and long-term subscriptions to movie channels. The TV industry is unable to sell its programming in large  
30 quantities on a unit per unit basis, such as the ordering of one program. Consumers prefer a unit sales approach because it

keeps costs down and allows the consumer to be more selective in their viewing.

5 In addition, viewership fragmentation, which has already begun, will increase. Programming not presented in a user friendly manner will suffer with a decrease in viewership and revenue. As programming presentation becomes more user friendly, users seek additional features and functional capabilities.

10 What is needed is a system which can deliver and present television programming through a user friendly interface which allows the consumer to easily select from among the many program choices.

15 What is needed is a set top converter that provides a user friendly interface for subscribers to access television programs.

What is needed is a set top converter with enhanced functionality.

What is needed is a set top converter that provides users with advanced features and capabilities.

20 What is needed is a method that allows efficient access to hundreds of television programming options.

What is needed is technology that upgrades the functionality of existing set top converters.

25 What is needed is hardware that provides an upgrade capability allowing the use of existing set top converter technology in advanced program delivery systems.

What is needed is a set top converter that provides an upstream communications capability between the set top converter and cable headend.

30 What is needed is a set top converter that provides a capability of generating menus for display.

What is needed is a set top converter that provides a simple way to select a program from a menu.

What is needed is a set top converter that allows users to subscribe on-screen to specialty channels.

5           What is needed is a set top converter that monitors subscriber viewing choices for statistical purposes.

What is needed is a set top converter that provides sophisticated on-screen television menus which can incorporate still video and moving video.

10           What is needed is a set top converter that provides a capability of scaling and redirecting video for menus. The present invention is addressed to fulfill these needs.

#### SUMMARY OF INVENTION

15           The present invention is a set top converter box or terminal for a television program delivery system. More specifically, the present invention is an advanced set top converter box that acts as a terminal in the viewer home. The set top terminal is a key component of a digital cable television delivery system. The set top terminal is an  
20           upgradeable system that provides for the decompression of digital program signals. The preferred set top terminal provides both a menu generation capability as well as a number of advanced features and functional capabilities.

25           The set top terminal of the present invention may be achieved through a set of hardware upgrades to any of the following embodiments: (1) an existing set top converter upgraded with a circuit card (which has a microprocessor electronically connected to the set top converter); (2) an industry standard decompression converter upgradeable by  
30           either an upgrade module or a menu generation card; and (3) a set top converter box capable of both decompression and menu generation. The hardware upgrades provide additional

advanced features and functional capabilities to any of these embodiments.

A number of advanced features and functional capabilities are supported by the preferred set top terminal. This set top terminal provides subscribers with a picture-on-picture capability without requiring a special television to support the capability. The set top terminal also supports a TV guide service, which provides subscribers with information on all programming available at its particular subscriber location. The set top terminal further includes the capability of querying viewers to establish, among other things, favorite channel lists, personal profile data and mood information. The set top terminal allows the subscriber to view promotional menus on future programming events.

The set top terminal supports additional capabilities using its hardware upgrades that allow subscribers to use other interactive services, for example, to engage in on-line question and answer sessions, to order and confirm airline tickets, and to access a variety of other data services. The set top terminal makes use of a digital tuner as a hardware upgrade to provide subscribers with a digital audio capability.

The preferred set top terminal may be used to control video tape machines, thereby simplifying the recording of programs. The set top terminal can, in conjunction with the program delivery system, easily support high definition television (HDTV). For subscribers living in remote locations, the set top terminal accommodates backyard satellite systems. In addition to all the features that the set top terminal supports with its current internal programming and upgradeability, additional features may be added or existing features increased through remote reprogramming of the set top terminal 220.



It is an object of the invention to provide a user friendly interface for subscribers to access television programs.

It is an object of the invention to allow users to easily navigate through hundreds of programming choices using on-screen menus.

It is an object of this invention to efficiently access hundreds of television programming options.

It is an object of this invention to upgrade the functionality of existing set top converters.

It is an object of this invention to provide an upgrade capability allowing the use of existing set top converter technology in an advanced program delivery system.

It is an object of this invention to provide an upstream communications capability between the set top converter and cable headend.

It is an object of this invention to provide a set top terminal capable of generating menus for display.

It is an object of this invention to allow users to subscribe on-screen to specialty channels.

It is an object of this invention to monitor subscriber viewing choices for statistical purposes.

It is an object of this invention to provide sophisticated on-screen television menus which can incorporate still video and moving video.

These and other objects and advantages of the invention will become obvious to those skilled in the art upon review of the following description, the attached drawings and appended claims.

### **DESCRIPTION OF THE DRAWINGS**

Figure 1 is a diagram of the primary components of the television delivery system.

Figure 2 is an overview of the television delivery system operations.

Figure 3 is a schematic of the operation of the primary components of the system.

5 Figure 4 is a block diagram of the hardware components of the set top terminal.

Figure 5a is a perspective front view of a set top terminal.

10 Figure 5b is a perspective rear view of a set top terminal.

Figure 6 is a schematic of a Turbo card upgrade for a set top terminal.

Figure 7a is a drawing of a frame format for program control information signal.

15 Figure 7b is a drawing of a frame format for a polling response from the set top terminal.

Figure 8 is a drawing of the basic menus used in the present invention, including the ten major menus represented by icons.

20 Figure 9a is a schematic of a basic decompression box with upgrade module and associated connections.

Figure 9b is a schematic of an alternative embodiment of a simple decompression box with upgrade module and associated connections.

25 Figure 10 is a more detailed block diagram of the components of a simple decompression box with upgrade module.

Figure 11 is a schematic of the set top terminal's upstream data transmission hardware.

30 Figure 12a is a schematic showing the components of the Level A, B, and C hardware upgrades.

Figure 12b is a schematic showing the components of the Level D hardware upgrade.

Figure 13a is a schematic showing the two parts of a remote control unit.

5           Figure 13b is a drawing of the preferred remote control unit.

Figure 14 is a diagram of the components of a set top terminal having a picture-on-picture capability.

10           Figure 15 is a drawing of a menu related to program catalogue services.

Figures 16a through 16d are drawings of viewer querying and mood question menus.

15           Figures 17a and 17b are drawings of the set top terminal hardware components that accommodate transparent channel switching.

Figure 18 is a drawing of an interactive television promotional menu for a set top terminal hardware upgrade.

20           Figures 19a and 19b are drawings of submenus for interactive television services using hardware upgrade Level A.

Figures 20a through 20d are drawings of interactive services using hardware upgrade Level B, which are related to on-screen airline reservations.

25           Figure 21 is a drawing of a menu for digital audio services.

Figure 22 is a drawing of a menu related to program guide services.

Figure 23 is a drawing of a menu related to high definition television (HDTV) programming.

30

**DETAILED DESCRIPTION OF THE PREFERRED  
EMBODIMENT**

A. **Television Program Delivery System Description**

1. **Introduction**

5           Figure 1 shows the present invention as part of an expanded cable television program delivery system 200 that dramatically increases programming capacity using compressed transmission of television program signals. Developments in digital bandwidth compression technology  
10           now allow much greater throughput of television program signals over existing or slightly modified transmission media. The program delivery system 200 shown provides subscribers with a user friendly interface to operate and exploit a six-fold or more increase in current program delivery capability.

15           Subscribers are able to access an expanded television program package and view selected programs through a menu-driven access scheme that allows each subscriber to select individual programs by sequencing a series of menus. The menus are sequenced by the subscriber using simple  
20           alpha-numeric and iconic character access or moving a cursor or highlight bar on the TV screen to access desired programs by simply pressing a single button, rather than recalling from memory and pressing the actual two or more digit numeric number assigned to a selection. Thus, with the press of a  
25           single button, the subscriber can advance from one menu to the next. In this fashion, the subscriber can sequence the menus and select a program from any given menu. The programs are grouped by category so that similar program offerings are found on the same menu.

30                                   2. **Major System Components**

          In its most basic form, the system uses a program delivery system 200 in conjunction with a conventional

concatenated cable television system 210. The program delivery system 200 generally includes (i) at least one operations center 202, where program packaging and control information are created and then assembled in the form of digital data, (ii) a digital compression system, where the digital data is compressed, combined/multiplexed, encoded, and mapped into digital signals for satellite transmission to the cable headend 208, and (iii) a set of in-home decompressors. The program delivery system 200 transports the digital signals to the cable headend 208 where the signals are transmitted through a concatenated cable television system 210. Within the cable headend 208, the received signals may be decoded, demultiplexed, managed by a local central distribution and switching mechanism, combined and then transmitted to the set top terminal 220 located in each subscriber's home over the cable system 210. Although concatenated cable systems 210 are the most prevalent transmission media to the home, telephone lines, cellular networks, fiberoptics, Personal Communication Networks and similar technology for transmitting to the home can be used interchangeably with this program delivery system 200.

The delivery system 200 has a reception region 207 with an in-home decompression capability. This capability is performed by a decompressor housed within a set top terminal 220 in each subscriber's home. The decompressor remains transparent from the subscriber's point of view and allows any of the compressed signals to be demultiplexed and individually extracted from the composite data stream and then individually decompressed upon selection by the subscriber. The decompressed video signals are converted into analog signals for television display. Such analog signals include NTSC formatted signals for use by a standard

television. Control signals are likewise extracted and decompressed and then either executed immediately or placed in local storage such as a RAM. Multiple sets of decompression hardware may be used to decompress video and control signals. The set top terminal 220 may then overlay or combine different signals to form the desired display on the subscriber's television. Graphics on video or picture-on-picture are examples of such a display.

Although a single digital compression standard (e.g., MPEG) may be used for both the program delivery system 200 and the concatenated cable system 210, the compression technique used may differ between the two systems. When the compression standards differ between the two media, the signals received by the cable headend 208 must be decompressed before transmission from the headend 208 to the set top terminals 220. Subsequently, the cable headend 208 must recompress and transmit the signals to the set top terminal 220, which would then decompress the signals using a specific decompression algorithm.

The video signals and program control signals received by the set top terminal 220 correspond to specific television programs and menu selections that each subscriber may access through a subscriber interface. The subscriber interface is a device with buttons located on the set top terminal 220 or on a portable remote control 900. In the preferred system embodiment, the subscriber interface is a combined alpha-character, numeric and iconic remote control device 900, which provides direct or menu-driven program access. The preferred subscriber interface also contains cursor movement and go buttons as well as alpha, numeric and iconic buttons. This subscriber interface and menu arrangement enables the subscriber to sequence

through menus by choosing from among several menu options that are displayed on the television screen. In addition, a user may bypass several menu screens and immediately choose a program by selecting the appropriate alpha-  
5 character, numeric or iconic combinations on the subscriber interface. In the preferred embodiment, the set top terminal 220 generates the menus that are displayed on the television by creating arrays of particular menu templates, and the set top terminal 220 displays a specific menu or submenu option  
10 for each available video signal.

### 3. Operations Center and Digital Compression System

The operations center 202 performs two primary  
15 services, packaging television programs and generating the program control information signal. At the operations center 202, television programs are received from external program sources in both analog and digital form. Figure 2 shows an embodiment of the operations center receiving signals from  
20 various external sources 212. Examples of the external program sources are sporting events, children's programs, specialty channels, news or any other program source that can provide audio or visual signals. Once the programs are received from the external program sources, the operations  
25 center 202 digitizes (and preferably compresses) any program signals received in analog form. The operations center 202 may also maintain an internal storage of programs. The internally stored programs may be in analog or digital form and stored on permanent or volatile memory sources,  
30 including magnetic tape or RAM. Subsequent to receiving programming, the operations center 202 packages the programs into the groups and categories which provide the optimal marketing of the programs to subscribers. For

example, the operations center 202 may package the same programs into different categories and menus for weekday, prime-time viewing and Saturday afternoon viewing. Also, the operations center 202 packages the television programs in a manner that enables both the various menus to easily represent the programs and the subscribers to easily access the programs through the menus.

The packaging of the digital signals is typically performed at the operations center 202 by computer assisted packaging equipment (CAP). The CAP system normally includes at least one computer monitor, keyboard, mouse, and standard video editing equipment. A programmer packages the signals by entering certain information into the CAP. This information includes the date, time slot, and program category of the various programs. The programmer and the CAP utilize demographic data and ratings in performing the packaging tasks. After the programmer selects the various programs from a pool of available programs and inputs the requisite information, the programmer, with assistance from the CAP, can select the price and allocate transponder space for the various programs. After the process is complete, the CAP displays draft menus or program schedules that correspond to the entries of the programmer. The CAP may also graphically display allocation of transponder space. The programmer may edit the menus and transponder allocation several times until satisfied with the programming schedule. During the editing, the programmer may direct the exact location of any program name on a menu with simple commands to the CAP.

The packaging process also accounts for any groupings by satellite transponder which are necessary. The operations center 202 may send different groups of programs to



different cable headends 208 and/or set top terminals 220. One way the operations center 202 may accomplish this task is to send different program packages to each transponder. Each transponder, or set of transponders, then relays a  
5 specific program package to specific cable headends 208 and/or set top terminals 220. The allocation of transponder space is an important task performed by the operations center 202.

10 The operations center 202 may also "insert" directions for filling local available program time in the packaged signal to enable local cable and television companies to fill the program time with local advertising and/or local programming. Consequently, the local cable headends 208 are not constrained to show only programs transmitted from  
15 the operations center 202. New set top converters will incorporate both digital and analog channels. Therefore, the cable headend 208 may combine analog signals with the digital signals prior to transmitting the program signals to the set top terminals 220.

20 After the CAP packages the programs, it creates a program control information signal to be delivered with the program package to the cable headend 208 and/or set top terminal 220. The program control information signal contains a description of the contents of the program  
25 package, commands to be sent to the cable headend 208 and/or set top terminal 220, and other information relevant to the signal transmission.

30 In addition to packaging the signal, the operations center 202 employs digital compression techniques to increase existing satellite transponder capacity by at least a 4:1 ratio, resulting in a four-fold increase in program delivery capability. A number of digital compression algorithms

currently exist which can achieve the resultant increase in capacity and improved signal quality desired for the system. The algorithms generally use one or more of three basic digital compression techniques: (1) within-frame (intraframe) compression, (2) frame-to-frame (interframe) compression, and (3) within carrier compression. Specifically, in the preferred embodiment, the MPEG 2 compression method is used. After digital compression, the signals are combined (multiplexed) and encoded. The combined signal is subsequently transmitted to various uplink sites 204.

There may be a single uplink site 204 or multiple uplink sites (represented by 204', shown in phantom in Figure 1) for each operation center 202. The uplink sites 204 may either be located in the same geographical place or may be located remotely from the operations center 202. Once the composite signal is transmitted to the uplink sites 204, the signal may be multiplexed with other signals, modulated, upconverted and amplified for transmission over satellite. Multiple cable headends 208 may receive such transmissions.

In addition to multiple uplinks, the delivery system 200 may also contain multiple operations centers. The preferred method for using multiple operations centers is to designate one of the operations centers as a master operations center and to designate the remaining operations centers as slave operations centers. In this configuration, the master operations center coordinates various functions among the slave operations centers such as synchronization of simultaneous transmissions and distributes the operations workload efficiently.

#### 4. Cable Headend

After the operations center 202 has compressed and encoded the program signals and transmitted the signals to the satellite, the cable headend 208 receives and further processes the signals before they are relayed to each set top terminal 220. Each cable headend site is generally equipped with multiple satellite receiver dishes. Each dish is capable of handling multiple transponder signals from a single satellite and sometimes from multiple satellites.

As an intermediary between the set top terminals 220 and the operations center 202 (or other remote site), the cable headend 208 performs two primary functions. First, the cable headend 208 acts as a distribution center, or signal processor, by relaying the program signal to the set top terminal 220 in each subscriber's home. In addition, the cable headend 208 acts as a network controller 214 by receiving information from each set top terminal 220 and passing such information on to an information gathering site such as the operations center 202.

Figure 3 shows an embodiment where the cable headend 208 and the subscriber's home are linked by certain communications media 216. In this particular embodiment, analog signals, digitally compressed signals, other digital signals and up-stream/interactivity signals are sent and received over the media 216. The cable headend 208 provides such signaling capabilities in its dual roles as a signal processor 209 and network controller 214.

As a signal processor 209, the cable headend 208 prepares the program signals that are received by the cable headend 208 for transmission to each set top terminal 220. In the preferred system, the signal processor 209 re-routes or demultiplexes and recombines the signals and digital information received from the operations center 202 and

allocates different portions of the signal to different frequency ranges. Cable headends 208 which offer different subscribers different program offerings may allocate the program signals from the operations center 202 in various  
5 manners to accommodate different viewers. The signal processor 209 may also incorporate local programming and/or local advertisements into the program signal and forward the revised signal to the set top terminals 220. To accommodate this local programming availability, the signal  
10 processor 209 must combine the local signal in digital or analog form with the operations center program signals. If the local cable system uses a compression standard that is different than the one used by the operations center 202, the signal processor 209 must also decompress and recompress  
15 incoming signals so they may be properly formatted for transmission to the set top terminals 220. This process becomes less important as standards develop (i.e., MPEG 2). In addition, the signal processor 209 performs any necessary signal decryption and/or encryption.

20 As a network controller 214, the cable headend 208 performs the system control functions for the system. The primary function of the network controller 214 is to manage the configuration of the set top terminals 220 and process signals received from the set top terminals 220. In the  
25 preferred embodiment, the network controller 214 monitors, among other things, automatic poll-back responses from the set top terminals 220 remotely located at each subscribers' home. The polling and automatic report-back cycle occurs frequently enough to allow the network  
30 controller 214 to maintain accurate account and billing information as well as monitor authorized channel access. In the simplest embodiment, information to be sent to the

network controller 214 will be stored in RAM within each subscriber's set top terminal 220 and will be retrieved only upon polling by the network controller 214. Retrieval may, for example, occur on a daily, weekly or monthly basis. The  
5 network controller 214 allows the system to maintain complete information on all programs watched using a particular set top terminal 220.

The network controller 214 is also able to respond to the immediate needs of a set top terminal 220 by modifying a  
10 program control information signal received from the operations center 202. Therefore, the network controller 214 enables the delivery system to adapt to the specific requirements of individual set top terminals 220 when the requirements cannot be provided to the operations center  
15 202 in advance. In other words, the network controller 214 is able to perform "on the fly programming" changes. With this capability, the network controller 214 can handle sophisticated local programming needs such as, for example, interactive television services, split screen video, and  
20 selection of different foreign languages for the same video. In addition, the network controller 214 controls and monitors all compressors and decompressors in the system.

The delivery system 200 and digital compression of the preferred embodiment provides a one-way path from the  
25 operations center 202 to the cable headend 208. Status and billing information is sent from the set top terminal 220 to the network controller 214 at the cable headend 208 and not directly to the operations center 202. Thus, program monitoring and selection control will take place only at the  
30 cable headend 208 by the local cable company and its decentralized network controllers 214 (i.e., decentralized relative to the operations center 202, which is central to the

program delivery system 200). The local cable company will in turn be in communication with the operations center 202 or a regional control center (not shown) which accumulates return data from the set top terminal 220 for statistical or billing purposes. In alternative system embodiments, the operations center 202 and the statistical and billing sites are collocated. Further, telephone lines with modems are used to transfer information from the set top terminal 220 to the statistical and billing sites.

5

10

#### 5. Set Top Terminal

The set top terminal 220 is the portion of the delivery system 200 that resides in the home of a subscriber. The set top terminal 220 is usually located above or below the subscriber's television, but it may be placed anywhere in or near the subscriber's home as long as it is within the range of the subscriber's remote control device 900. In some aspects, the set top terminal 220 may resemble converter boxes already used by many cable systems. For instance, each set top terminal 220 may include a variety of error detection, decryption, and coding techniques such as anti-taping encoding. However, it will become apparent from the discussion below that the set top terminal 220 is able to perform many functions that an ordinary converter box cannot perform.

15

20

25

30

The set top terminal 220 has a plurality of input and output ports to enable it to communicate with other local and remote devices. The set top terminal 220 has an input port that receives information from the cable headend 208. In addition, the unit has at least two output ports which provide communications from the set top terminal 220 to a television and a VCR. Certain menu selections may cause the set top terminal 220 to send control signals directly to the VCR to

automatically program or operate the VCR. Also, the set top terminal 220 contains a phone jack which can be used for maintenance, trouble shooting, reprogramming and additional customer features. The set top terminal 220 may  
5 also contain stereo/audio output terminals and a satellite dish input port.

Functionally, the set top terminal 220 is the last component in the delivery system chain. The set top terminal 220 receives compressed program and control  
10 signals from the cable headend 208 (or, in some cases, directly from the operations center 202). After the set top terminal 220 receives the individually compressed program and control signals, the signals are demultiplexed, decompressed, converted to analog signals (if necessary) and  
15 either placed in local storage (from which the menu template may be created), executed immediately, or sent directly to the television screen.

After processing certain signals received from the cable headend 208, the set top terminal 220 is able to store menu  
20 templates for creating menus that are displayed on a subscriber's television by using an array of menu templates. Before a menu can be constructed, menu templates must be created and sent to the set top terminal 220 for storage. A microprocessor uses the control signals received from the  
25 operations center 202 or cable headend 208 to generate the menu templates for storage. Each menu template may be stored in volatile memory in the set top terminal 220. When the set top terminal receives template information it demultiplexes the program control signals received from the  
30 cable headend 208 into four primary parts: video, graphics, program logic and text. Each menu template represents a different portion of a whole menu, such as a menu

background, television logo, cursor highlight overlay, or other miscellaneous components needed to build a menu. The menu templates may be deleted or altered using control signals received from the operations center 202 or cable headend 208.

5           Once the menu templates have been stored in memory, the set top terminal 220 can generate the appropriate menus. In the preferred embodiment, the basic menu format information is stored in memory located within the set top terminal 220 so that the microprocessor may locally access the information from the set top terminal instead of from an incoming signal. The microprocessor next generates the appropriate menus from the menu templates and the other menu information stored in memory. The set top terminal 10           220 then displays specific menus on the subscriber's television screen that correspond to the inputs the subscriber selects.

15           If the subscriber selects a specific program from a menu, the set top terminal 220 determines on which channel the program is being shown, demultiplexes and extracts the single channel transmitted from the cable headend 208. The set top terminal 220 then decompresses the channel and, if necessary, converts the program signal to an analog NTSC signal to enable the subscriber to view the selected program. 20           The set top terminal 220 can be equipped to decompress more than one program signal, but this would unnecessarily add to the cost of the unit since a subscriber will generally only view one program at a time. However, two or three decompressors may be desirable to provide picture-on- 25           picture capability, control signal decompression, enhanced channel switching or like features. 30



In addition to menu information, the set top terminal 220 may also store text transmitted from the cable headend 208 or the operations center 202. The text may inform the subscriber about upcoming events, billing and account status, new subscriptions, or other relevant information. The text will be stored in an appropriate memory location depending on the frequency and the duration of the use of the textual message.

Also, optional upgrades are available to enhance the performance of a subscriber's set top terminal 220. These upgrades may consist of a cartridge or computer card (not shown) that is inserted into an expansion slot in the set top terminal 220 or may consist of a feature offered by the cable headend 208 or operations center 202 to which the user may subscribe. Available upgrades may include on line data base services, interactive multi-media services, access to digital radio channels, and other services.

In the simplest embodiment, available converter boxes such as those manufactured by General Instruments or Scientific Atlanta, may be modified and upgraded to perform the functions of a set top terminal 220. The preferred upgrade is a circuit card with a microprocessor which is electronically connected to or inserted into the converter box.

## 6. Remote Control Device

The primary conduit for communication between the subscriber and the set top terminal 220 is through the subscriber interface, preferably a remote control device 900. Through this interface, the subscriber may select desired programming through the system's menu-driven scheme or by directly accessing a specific channel by entering the actual channel number. Using the interface, the subscriber can

navigate through a series of informative program selection menus. By using menu-driven, iconic or alpha-character access, the subscriber can access desired programs by simply pressing a single button rather than recalling from memory and pressing the actual channel number to make a selection. The subscriber can access regular broadcast and basic cable television stations by using either the numeric keys on the remote control 900 (pressing the corresponding channel number), or one of the menu icon selection options.

In addition to enabling the subscriber to easily interact with the cable system 200, the physical characteristics of the subscriber interface 900 should also add to the user friendliness of the system. The remote control 900 should easily fit in the palm of the user's hand. The buttons of the preferred remote control 900 contain pictorial symbols that are easily identifiable by the subscriber. Also, buttons that perform similar functions may be color coordinated and consist of distinguishing textures to increase the user friendliness of the system.

#### 7. Menu-Driven Program Selection

The menu-driven scheme provides the subscriber with one-step access to all major menus, ranging from hit movies to sport specials to specialty programs. From any of the major menus, the subscriber can in turn access submenus and minor menus by cursor or alpha-character access.

There are two different types of menus utilized by the preferred embodiment, the Program Selection menus and the During Program menus. The first series of menus, Program Selection menus, consists of an Introductory, a Home, Major menus, and Submenus. The second series of menus, During Program menus, consists of two primary types, Hidden menus and the Program Overlay menus.

Immediately after the subscriber turns on the set top terminal 220, the Introductory menu welcomes the subscriber to the system. The Introductory menu may display important announcements from the local cable franchise, advertisements from the cable provider, or other types of messages. In addition, the Introductory menu can inform the subscriber if the cable headend 208 has sent a personal message to the subscriber's particular set top terminal 220.

After the Introductory menu has been displayed the subscriber may advance to the next level of menus, namely the Home menu. In the preferred embodiment, after a certain period of time, the cable system will advance the subscriber by default to the Home menu. From the Home menu, the subscriber is able to access all of the programming options. The subscriber may either select a program directly by entering the appropriate channel number from the remote control 900, or the subscriber may sequence through incremental levels of menu options starting from the Home menu. The Home menu lists categories that correspond to the first level of menus called Major menus.

If the subscriber chooses to sequence through subsequent menus, the subscriber will be forwarded to the Major menu that corresponds to the chosen category from the Home menu. The Major menus further refine a subscriber's search and help guide the subscriber to the selection of his choice.

From the Major menus, the subscriber may access several submenus. From each submenu, the subscriber may access other submenus until the subscriber finds a desired television program. Similar to the Major menu, each successive level of Submenus further refines the subscriber's search. The system also enables the subscriber to skip

certain menus or submenus and directly access a specific menu or television program by entering the appropriate commands on the remote control 900.

5           The During program menus (including Hidden Menu  
and Program Overlay Menus) are displayed by the set top  
terminal 220 only after the subscriber has selected a  
television program. In order to avoid disturbing the  
subscriber, the set top terminal 220 does not display the  
Hidden Menu until the subscriber selects the appropriate  
10       option to display a Hidden Menu. The Hidden Menu contain  
options that are relevant to the program selected by the  
viewer. For example, a Hidden Menu may contain options  
that enable a subscriber to enter an interactive mode or  
escape from the selected program.

15           Program Overlay Menus are similar to Hidden Menu  
because they occur during a program and are related to the  
program being viewed. However, the Program Overlay Menus  
are displayed concurrently with the program selected by the  
subscriber. Most Program Overlay Menus are small enough on  
20       the screen to allow the subscriber to continue viewing the  
selected program comfortably.

#### B. Detailed Set Top Terminal Description

25           The set top terminal 220 receives and manipulates  
signals from the cable headend 208. The set top terminal  
220 is equipped with local computer memory and the  
capability of interpreting the digitally compressed signal to  
produce menus for the subscriber. The remote control 900  
communicates the subscriber's selections to the set top  
terminal 220. The subscriber's selections are generally based  
30       upon menus or other prompts displayed on the television  
screen.

It is preferred that the signal reaches the subscriber's home in a compressed format and is decompressed prior to viewing. Included in the delivered program signal is information that enables equipment at the subscriber's home to display menus for choosing particular programs. Depending on the particular embodiment, the television program signal may arrive at the subscriber's home through one or more connections such as coaxial cables, fiber cables, twisted pairs, cellular telephone connections, or personal communications network (PCN) hookups.

The program control information signal is generated by the operations center 202 and provides the network controller 214 with data on the scheduling and description of programs. In an alternate configuration, this data is sent directly to the set top terminal 220 for display to the subscriber. In the preferred embodiment, the program control information signal is stored and modified by the network controller 214 and sent to the set top terminal 220 in the form of a set top terminal control information stream (STTCIS). The set top terminal 220 integrates either the program control information signal or the STTCIS with data stored in the memory of the set top terminal 220 to generate on-screen menus that assist the subscriber in choosing programs for display.

The types of information that can be sent using the program control signal include: number of program categories, names of program categories, what channels are assigned to a specific category (such as specialty channels), names of channels, names of programs on each channel, program start times, length of programs, description of programs, menu assignment for each program, pricing, whether there is a sample video clip for advertisement for

the program, and any other program, menu or product information.

5 With a minimal amount of information being communicated to the set top terminal 220 on a regular basis, the set top terminal 220 is able to determine the proper menu location for each program and the proper time and channel to activate for the subscriber after a menu selection. The program control information signal and STTCIS can be formatted in a variety of ways and the on-screen menus can be produced using many different methods. For instance, if the program control information signal carries no menu format information, the menu format for creating the menus can be fixed in ROM at the set top terminal 220. In the preferred embodiment, the menu format information is stored at the set top terminal 220 in a temporary memory device such as a RAM or EPROM. New menu format information is sent via the program control information signal or the STTCIS to the set top terminals 200 whenever a change to a menu format is desired.

15  
20 In the simplest embodiment, the menu formats remain fixed and only the text changes. In this way the program control information signal can be limited to primarily text and a text generator can be employed in the set top terminal 220. Another simple embodiment uses a separate channel full-time (large bandwidth) just for the menu information.

25  
30 Live video signals may be used in windows of certain menus. These video signals can be transmitted using the program control information signal or STTCIS, or can be taken off channels being transmitted simultaneously with the menu display. Video for menus, promos or demos may be sent to the set top terminal 220 in several formats, including (1) on a dedicated channel, (2) on a regular program channel

and scaled to size, or (3) along with the program control information signal. However, in the preferred embodiment, a large number of short promos or demo video is sent using a split screen technique on a dedicated channel. A multiple window technique may be used with the menus to display a description of a program and one or more video frames that assist the subscriber in selecting the program.

Figure 4 shows the basic hardware components of the set top terminal 220. The set top terminal 220 has a tuner 603, digital demodulator 606, decryptor 600, and demultiplexers 609, 616 as well as audio equipment 612 and a remote control interface 626 for receiving and processing signals from the remote control unit 900. An optional modem 627 allows communication between a microprocessor 602 and the cable headend 208. An NTSC encoder 625 provides a standard NTSC video output.

The microprocessor 602 is capable of executing program instructions stored in memory. These instructions allow a user to access various menus by making selections on the remote control 900.

The manner in which the video is decompressed and the menus are generated from the program control information signal or STTCIS varies depending on the specific embodiment of the invention. Video decompressors 618 and 622 may be used if the video is compressed. The program control information signal may be demultiplexed into its component parts, and a video decompressor 618, graphic decompressor, text generator and video combiner 624 may be used to assist in creating the menus.

In addition to the menu format information that is stored in graphics memory, the set top terminal 220 also stores data, tracking those programs that have been selected

for viewing. By gathering this data, the set top terminal 220 can maintain an accurate record of all programs accessed/watched by storing the data in EEPROM or RAM. Subsequently, this data can be transmitted to the cable headend 208, where it can be used in carrying out network control and monitoring functions. Such data transmissions between the set top terminal 220 and cable headend 208 can be accomplished, for example, through upstream transmission over the cable network or over telephone lines through the use of telephone modems. Where upstream transmission over the cable network is used, the set top terminals 220 can complete data transmissions on a scheduled (e.g., using a polling response or status report to respond to polling requests sent from the cable headend 208) or as-needed (e.g., using a random access technique) basis.

Figure 5a shows the front panel of the set top terminal 220, which includes an infrared sensor 630 and a series of LED displays 640. The LED displays 640 may indicate with an icon or a letter (e.g. A-K) the major menu currently selected by the set top terminal 220 or the channels selected directly by a user, or menu channel selections (e.g., from 1 to 50). Further displays may include current channel, time, volume level, sleep time, parental lock (security), account balance, use of a hardware upgrade, second channel being recorded by VCR, use of the Level D music hardware upgrade in a separate room, and any other displays useful to a subscriber to indicate the current status of the set top terminal 220. The LEDs 640 may also provide an indication of the digital audio channel currently tuned.

The set top terminal 220 includes a flapped opening 635 on its front that allows the insertion of a magnetic



cartridge (or similar portable storage device, including optical disk, ROM, EPROM, etc. not shown). This cartridge opening 635 allows the set top terminal 220 to be upgraded or reprogrammed locally with the use of a magnetic tape cartridge.

5

On the top or cover of the set top terminal 220 are located pushbutton controls 645. Any function that can be performed on the remote 900 may also be performed at the set top terminal 220 using the duplicative pushbutton controls 645.

10

Figure 5b shows the back of the set top terminal 220, which includes a pair of output terminals 650, pair of input terminals 652, pair of stereo/audio output terminals 654, satellite dish input port 656, telephone jack 658 and an RS-422 port 660. In addition, an upgrade port 662 and a cover plate 664 are held in place by a series of sheet metal screws. One of the output terminals 650 is for a television and the other is for a VCR. The set top terminal 220 is equipped to handle incoming signals on one or two cables using the input terminals 652. The phone jack 658 and an RS-232 or RS-422 port 660 are provided for maintenance, trouble shooting, reprogramming and additional customer features. In alternate embodiments, the telephone jack 658 may be used as the primary mode of communication between the cable headend 208 and the set top terminal 220. This connection is possible through the local telephone, cellular telephone or a personal communications network (PCN).

15

20

25

The basic programming of each set top terminal 220 is located on ROM within the set top terminal 220. Random access memory, the magnetic cartridge capability, and the expansion card slot 635 each allow upgrades and changes to be easily made to the set top terminal 220.

30

In the preferred embodiment, the set top terminal 220 includes a hardware upgrade port 662, in addition to expansion card slots. The hardware upgrade port 662 accommodates a four-wire (or more) connection for: (1) error corrected, decrypted data output of the set top terminal 220, (2) a control interface, (3) decompressed video output, and (4) a video input port. In the preferred embodiment, multiple wires are used to perform each of the four functions. The four sets of wires are combined in a single cable with a single multipin connector.

In the preferred embodiment, multipin connections may be used for the multiwire cable. The multipin connection 662 may range from DB9 to DB25. A variety of small computer systems interface (SCSI) ports may also be provided. Alternatively, four or more ports may be provided instead of the single port depicted.

Another port 662 is used to attach the various hardware upgrades described below to a set top terminal 220. The preferred embodiment has a number of hardware upgrades available for use with a set top terminal 220, including: (1) a Level A interactive unit, (2) a Level B interactive unit, (3) a Level C interactive unit with compact disc capability, (4) a Level D digital radio tuner for separate room use, and (5) a Level E information download unit. Each of these upgrades may be connected to the set top terminal 220 unit through the upgrade port 662 described earlier. The same four wires in a single cable described earlier may be used.

Existing set top converter boxes such as those made by Scientific Atlanta or General Instruments are presently unequipped to handle the menu selection system of the present invention. Thus, hardware modifications are

necessary in order to use the menu selection system with existing set top converter technology.

5 A Turbo Card addition to a set top converter is depicted in Figure 6. The Turbo Card 700 shown provides the additional functionality needed to utilize the menu system with existing set top converter technology. The primary functions the Turbo Card 700 adds to the set top converter are the interpreting of program control information signals, generating of menus, sequencing of menus, and, ultimately, the ability of the viewer to select a channel through the menu system without entering any channel identifying information. 10 The turbo card also provides a method for a remote location, such as the cable headend 208, to receive information on programs watched and control the operation of the set top converter and Turbo Card 700. The programs watched information and control commands may be passed from the cable headend 208 to the Turbo Card 700 using telephone lines. 15

The primary components of the Turbo Card 700 are a 20 PC chip CPU 702, a VGA graphic controller 704, a video combiner 706, logic circuitry 708, NTSC encoder 710, a receiver 712, demodulator 714, and a dialer 716. The Turbo Card 700 operates by receiving the program control information signal from the cable headend 208 through the coaxial cable. The logic circuitry 708 of the Turbo Card 700 receives data, infrared commands, and synchronization signals from the set top converter. Menu selections made by the viewer on the remote control 900 are received by the set top converter's IR equipment and passed through to the Turbo Card 700. The Turbo Card 700 interprets the IR signal and determines the program (or menu) the viewer has selected. 25 30 The Turbo Card 700 modifies the IR command to

send the program selection information to the set top converter 221. The modified IR command contains the channel information needed by the set top converter. Using the phone line and dialer 716, the Turbo Card 700 is able to transmit program access information to the cable headend 208.

In the preferred embodiment, program access information, that is what programs the viewer watched, is stored at each set top terminal 220 until it is polled by the network controller 214 using a polling request message format as shown in Figure 7a. This frame format 920 consists of six fields, namely: (1) a leading flag 922 at the beginning of the message, (2) an address field 924, (3) a subscriber region designation 926, (4) a set top terminal identifier 928 that includes a polling command/response (or P/F) bit 930, (5) an information field 932, and (6) a trailing flag 934 at the end of the message. Figure 7b shows a response frame format 920' (similar to the frame format 920 end, therefore, commonly numbered with the frame depicted in Figure 7a, but with the prime indicator added for clarity) for information communicated by the set top terminal 220 to the network controller 214 in response to the polling request of Figure 7a.

The eight-bit flag sequence 922 that appears at the beginning and end of a frame is used to establish and maintain synchronization. Such a sequence typically consists of a "01111110" bit-stream. The address field 924 designates a 4-bit address for a given set top terminal 220. The subscriber region designation 926 is a 4-bit field that indicates the geographical region in which the subscriber's set top terminal 220 is housed. The set top terminal identifier 928 is a 16-bit field that uniquely identifies each set top terminal 220 with a 15-bit designation followed by an

appended P/F bit 930. Although field size is provided by this example, a variety of sizes can be used with the present invention.

5 The P/F bit 930 is used to command a polling response from the set top terminal 220 addressed, as described below. The response frame format 920' also provides a variable-length information field 932' for other data transmissions, such as information on system updates. The frame format 920' ends with an 8-bit flag (or trailing flag) 934' that is  
10 identical in format to the leading flag 922', as set forth above. Other frame formats (e.g., MPEG) will be apparent to one skilled in the art and can be easily adapted for use with the system.

15 As summarized above, images or programs may be selected for display by sequencing through a series of menus. Figure 8 is an example of one possible structure for a series of menus. Generally, the sequence of menus is structured with an introductory menu, a home menu, various major menus and a multitude of submenus. The submenus can include  
20 promo menus and during program menus. For example, at the home menu portion of the sequence of menus and corresponding software routines, a subscriber may select one of the major menus and start a sequence of menu displays. Alternatively, a subscriber may go directly to a major menu by  
25 depressing a menu select button on remote control 900.

At any time during the menu sequence, the subscriber may depress a major menu button to move into another series of menus. In this way, a subscriber may move from major menu to major menu.

30 The various software subroutines executed by the microprocessor 602 allow a subscriber to sequence the menus, navigating through the various menus of the present

invention. A subscriber may sequence back through menus or return to the home menu with a single touch of the home menu button on remote 900.

5 An introductory menu screen 1000 automatically appears upon power-up and initialization of the set top terminal 220. From this introductory menu screen 1000, the set top terminal software will normally advance the subscriber to the home menu screen 1010. The home menu 1010 is the basic menu that the subscriber will return to in  
10 order to make the first level of viewing decisions. When the set top terminal software is displaying the home menu 1010, the subscriber is able to access any television programming option. The software allows programming options to be entered through cursor movement on the screen and directly  
15 by button selection on the remote control 900.

In the normal progression through the menu screens, the software will forward the subscriber to a major menu screen 1020 in response to the subscriber's remote control 900 selection or highlighted cursor selection from the home  
20 menu screen 1010. The selections displayed on the home menu 1010 are for large categories of programming options.

Following the major menu 1020, the subscriber may navigate through one or more submenu screens 1050 from which the subscriber may choose one particular program for  
25 viewing. For most programming selections, the user will proceed from the home menu 1010 to a major menu 1020 and then to one or more submenus 1050. However, for certain programming options or functions of the set top terminal 220, the user may skip one or more menus in the  
30 sequence.

The During Program Menus 1200 are submenus enabled by the set top terminal software only after the

subscriber has selected a television program. These menus provide the subscriber with additional functionality and/or additional information while viewing a selected program. The During Program Menus 1200 sequence can be further subdivided into at least two types of menus, Hidden Menus 1380 and Program Overlay Menus 1390.

To avoid disturbing a subscriber during viewing of a program, the Hidden Menus 1380 are not shown to the subscriber but instead "reside" at the set top terminal 220 microprocessor 602. The microprocessor 602 awaits a button entry either from the remote control 900 or set top terminal 220 buttons before executing or displaying any Hidden Menu 1380 options. The set top terminal software provides the subscriber with additional functions such as entering an interactive mode or escaping from a selected program through use of Hidden Menus 1380.

Program Overlay Menus 1390 are similar to Hidden Menus 1380. However, the Program Overlay Menus 1390 are overlaid onto portions of the displayed video and not hidden. The software for the Program Overlay Menus 1390 allows the subscriber to continue to watch the selected television program with audio but places graphical information on a portion of the television screen. Most Program Overlay Menus 1390 are graphically generated to cover small portions of video. Some Overlays 1390 which are by their nature more important than the program being viewed will overlay onto greater portions of the video. Examples of types of overlay menus 1390 include Notification Menus 1392 and Confirmation Menus 1394. In the preferred embodiment, the software for the Program Overlay Menus 1390 controls the reduction or scales down the (entire)

programs video and redirects the video to a portion of the screen.

5 Submenus provide the cost of viewing the program and the program's length in hours and minutes. From the submenus, the subscriber is given at least three options: (1) to purchase a program, (2) to return to the previous menu, and (3) to press "go" and return to regular TV. The subscriber may also be given other options such as previewing the program.

10 Using an on-screen menu approach to program selection, there is nearly an unlimited number of menus that can be shown to the subscriber. The memory capability of the set top terminal 220 and the quantity of information that is sent using the program control information signal are the only limits on the number of menus and amount of information that can be displayed to the subscriber. The approach of using a series of menus in a simple tree sequence is both easy for the subscriber to use and simply implemented by the set top terminal 220 and remote control device 900 with cursor movement. A user interface software programmer will find many obvious variations from the preferred embodiment described.

25 The set top terminal 220 generates and creates menus using, in part, information stored in its graphics memory. A background graphics file 800 will store menu backgrounds and a logo graphics file will store any necessary logos. A menu display and cursor graphics file will store menu display blocks and cursor highlight overlays as well as any other miscellaneous files needed to build the menus. Using this method of storing menus, the menus can be changed by reprogramming the graphics memory of the set top terminal



220 through instructions from either the network controller 214 or operations center 202.

The microprocessor 602 performs the steps required to create a menu using stored information. The  
5 microprocessor 602 fetches a background file, logo file, menu display and cursor file in most instances. The microprocessor 602 fetches text from long-term, intermediate-term, or short-term storage depending on where the text is stored. Using a video combiner (or like device), the stored  
10 information is combined with video and the entire image is sent to the television screen for display.

In the preferred embodiment, a graphics controller is used to assist the set top terminal 220 in generating menus. Menu generation by the set top terminal 220 begins with the  
15 building of a major menu screen, which includes background graphics for that major menu. The background graphics may include an upper sash across the top of the screen and a lower sash across the bottom of the screen. The background graphics may be generated from the background graphics file  
20 800 in the memory files of the graphics memory (preferably EEPROM). In addition, logo graphics may be generated. Such graphics typically include an icon window, a cable company logo, a channel company logo, and two "go" buttons.

Preferably, the text for each major menu is generated  
25 separately by a text generator in the set top terminal 220. Those portions of the text that generally remain the same for a period of weeks or months may be stored in EEPROM or other local storage. Text which changes on a regular basis, such as the movie titles (or other program selections), is  
30 transmitted to the set top terminal 220 by either the operations center 202 or the network controller 214 of the cable headend 208. In this manner, the cable headend 208

may change the program selections available on any major menu 1020 by modifying the program control information signal sent by the operations center 202 and transmitting any changes using the STTCIS.

5           Day, date and time information are added to each major menu. This information is sent from the operations center 202, the cable headend 208 (signal processor 209 or network controller 214), the uplink site, or generated by the set top terminal 220 internally.

10           The creation and display of program description submenus is performed by the set top terminal 220 in a manner similar to that described above. Each submenu may be created in parts and combined before being sent to the television screen. Preferably, background graphics and upper and lower sashes are used. Likewise, a video window and half-strip window can be generated from information in storage on the EEPROM.

15           In addition to graphics and text, some submenus include windows that show video. Such video may be still or moving pictures. Still pictures may be stored in a compressed format (such as JPEG) at the set top terminal 220. Video stills may be transmitted by the operations center 202 through the program control information signal from time to time.

20           Moving video picture is obtained directly from a current video feed as described above. Depending on video window size, this may require manipulation of the video signal, including scaling down the size of the video and redirecting the video to the portion of the menu screen which is within the video window of the menu. Alternatively, the video may be obtained from a split screen channel. Such a method involves the use of split screen video techniques to send

25

30

multiple video clips on a single channel at a given time. The set top terminal 220 would scale the picture, if necessary, and redirect it to the correct position on the screen using known scaling and positioning techniques. Additional  
5 circuitry may be required in the set top terminal 220 to perform adequate scaling and repositioning.

To avoid the need for redirecting video into the portion of the screen which houses the video window, masking and menu graphics may be used to cover the portions of the  
10 channel video that are not needed. This masking technique allows the split screen video to remain in the same portion of the screen that it is transmitted by the operations center 202. The masking is then adjusted to cover the undesired portions of the screen. These masks are stored in the  
15 background graphics file similarly to other background files for menus.

The split screen video technique may also be used for promoting television programming. Since a great number of short video clips may be sent continuously, full or partial  
20 screen promotionals (or informationals) may be provided to the subscriber. With this large quantity of promotional video, the subscriber is given the opportunity to "graze" through new movie or television programming selections. The subscriber simply grazes from promotional video to  
25 promotional video until the desired television program is discovered.

### C. Detailed Description of Advanced Set Top Terminal

#### 30 1. Overview

The present invention relates to advances in the set top terminal 220 described above. In particular, the present invention may be achieved through a set of hardware

upgrades or additions to the following embodiments: (1) an existing set top converter (not shown) upgraded with a Turbo Card 700 or the like; (2) an industry standard digital decompression converter box (as shown in Figures 9a and 9b below) upgradeable by either an upgrade module or a menu generation card; or (3) a set top terminal 200 capable of both decompression and menu generation. The set of hardware upgrades described below can be used to provide additional advanced features and functional capabilities to any of these embodiments.

Table A shows several exemplary hardware configurations that may be used to achieve the goals of the present invention. In particular, Table A shows four columns of set top converter technology, which may be modified to produce the various set top capabilities shown in the three rows of the table.

**TABLE A**

	Existing Analog Set Top Converter	Set Top Converter With Digital Decompression Capability	Set Top Converter With Digital Decompression and Menu Generation Capabilities	Advanced Set Top Terminal
Decompression Capability	N/A	Built-In	Built-In	Built-In
Menu Generation Capability	Turbo Card	Upgrade Module or Menu Generation Card	Built-In	Built-In
Advanced Features	Level A-C Hardware Upgrades or Expansion Card	Level A-E Hardware Upgrades or Expansion Card	Level A-E Hardware Upgrades or Expansion Card	Built-In

The table shows the various inherent functional capabilities of each set top converter, and how each may be modified or upgraded, if necessary, to achieve the objectives of the present invention. From left to right, the columns of the table span the various alternatives for balancing those capabilities that may be built into set top converters or terminals, on the one hand, and those capabilities that can be provided through, for example, an upgrade module,

expansion card or hardware upgrade of the present invention, on the other. This balance allows a designer or manufacturer of set top converters to choose between adding advanced functionality to an existing converter box or, instead, producing a converter with additional built-in features that increase cost and complexity of the converter or terminal.

The first column of Table A shows how an existing analog set top converter can be modified to provide menu generation capability through the use of the Turbo Card. In addition to the Turbo Card, such an existing analog set top converter may be further modified to provide any of the advanced features described below through the use of the Level A, Level B and Level C hardware upgrades or an expansion card. Such existing set top converter boxes are currently manufactured by Scientific Atlanta and General Instruments, among others. These converter boxes have been designed for use with analog waveforms and, as a result, digital decompression capabilities are not applicable.

The second column of Table A shows a set top converter with digital decompression capability. This converter is a simple decompression box which may eventually become the industry standard. The simple decompression boxes may be modified to provide the enhanced functionality of the present invention. For example, a simple decompression box may be modified to produce menu generation capability through the use of an upgrade module or menu generation card. In addition, other advanced features may be added to a simple decompression box through modifications that include any of the Level A through E hardware upgrades or an expansion card. Each of these modifications are described below.

The third column of Table A shows a set top converter that has built-in digital decompression and menu generation capabilities. Thus, in order to achieve the enhanced functionality of the present invention, other advanced features may be provided through hardware modification. Such modification may be accomplished through the use of any of the Level A through E hardware upgrades or the expansion card, as explained below.

The fourth column of Table A shows an advanced set top terminal having decompression, menu generation, and advanced functional capabilities. Each of these capabilities are built in to the terminal itself. In this way, achieving the enhanced performance of the set top terminal in accordance with the present invention would require no hardware modification.

In the preferred embodiment, the advanced set top terminal 220 of the present invention has the capability, among other things, of receiving tiered programming from the network controller. Tiered programming allows different users to view different video even though the subscribers are "tuned" to the same channel. For example, the network controller 214 may know the demographics of its subscribers through a database, by "learning" from prior subscriber choices, from an interactive selection, or from other means. Using the demographics information, the network controller 214 may target commercials to the correct audience by showing different commercials to subscribers with different demographics. Even though subscribers will believe they are "tuned" to one channel, each subscriber will be switched to a different channel for the tiered video. Alternatively, subscribers may be offered an option of several commercials from which to choose.

To accommodate foreign speaking subscribers, multiple audio channels for television programming may be provided. In this way, the subscriber may be shown menus of programs available in the subscriber's native language. The function of choosing the correct audio to correspond to the selected language may be handled by either the set top terminal 220 or the network controller 214 depending upon the configuration. Local programming in several languages or additional audio channels for a foreign language translation of a popular television program may be provided by the network controller 214. Using a picture-on-picture feature, sign language may be similarly made available to certain set top terminals 220 for the deaf. Also, a text overlay may easily be produced on the lower part of the screen for the deaf.

Typically, each video signal is received at the set top terminal 220 along with four audio channels. Two of these audio channels will preferably be used for left and right stereo audio reception of the video signal being displayed. The remaining two audio signals may be used for alternative languages. For example, where a video signal is received by the set top terminal 220, two of the audio channels will provide the stereo audio signals for that video in English, with the other two audio channels providing mono audio signals in French and Spanish. In this way, each video signal received at the set top terminal 220 can accommodate at least two foreign languages. Where stereo audio channels are not desired, the audio channels in English can be set to a single signal, providing mono audio reception, and increasing the multiple language audio channel capability to three foreign languages.

In other embodiments, the network controller 214 can act as a central computer and provide intra-set top terminal

interactive games, inter-set top terminal interactive games, computer bulletin board type services, message services (Electronic mail) etc. For example, a subscriber may play war games with five (anonymous) fellow subscribers each in their  
5 own home each operating a separate tank. The network controller 214 gathers the players via set top terminal 220 communications and acts as the referee. A bulletin board or message system can be set up to discuss a particular program such as "Twin Peaks Whodunit" for enthusiasts. These  
10 interactive features are further described below with the interactive services level B menu and the set top terminal hardware upgrade level B interactive unit.

In order to achieve the required throughput of video and audio information for the system, digital compression techniques for video are employed. As a result, the set top  
15 terminal 220 typically must decompress any digitally compressed program signals that it receives. Methods of decompression are a function of the compression technique used in the program delivery system.

20 There are three basic digital compression techniques: within-frame (intraframe), frame-to-frame (interframe), and within-carrier compression. Various compression methods may be used with these techniques. Such methods of compression, which include vector quantization and discrete cosine transform methodologies, are known to those skilled  
25 in the art.

Several standard digital formats representing both digitizing standards and compression standards have also been developed. For example, JPEG (joint photographic  
30 experts group) is a standard for single picture digitization. Motion picture digitization may be represented by standards such as MPEG or MPEG 2 (motion picture engineering group



specification). In addition to these standards, other proprietary standards have been developed. Although MPEG and MPEG 2 for motion pictures are preferred in the present invention, any reliable digital format with compression may be used.

5 Various hybrids of the above compression techniques and methods have been developed by several companies including AT&T, Compression Labs, Inc., General Instruments, Scientific-Atlanta, Philips, and Zenith. Any of  
10 the compression techniques developed by these companies, as well as other techniques known to those skilled in the art, may be used with the present invention.

2. Advanced Set Top Terminal Major Components and Upgrades

15 a. Decompression Box with Upgrade Module

The preferred program delivery system uses digitally  
20 compressed signals and, as a result, the preferred subscriber equipment configuration must be capable of decompressing and processing such digitally compressed signals. Figure 9a diagrams the basic interplay between an upgrade module 700 and a simple decompression box 302. The upgrade module  
25 300 can be connected to the decompression box 302 through a port similar to the upgrade port 662 described above (Figure 5b). The simple decompression box 302 shown is preferably a future industry standard decompression box capable of communicating with an upgrade module 300 to  
30 enhance functionality.

The upgrade module 300 provides menu generation capability to the simple decompression box 302. The microprocessor of the simple decompression box 302 communicates with the microprocessor in the upgrade

module 300 to provide the full functionality of a set top terminal 220.

5 In the preferred embodiment, multipin connections may be used for a multiwire cable connecting the simple decompression box 302 with the upgrade module 300. The multipin connection may range from DB9 to DB25. A SCSI, or small computer systems interface, port (not shown) may also be provided. Alternatively, four or more ports may be provided instead of the single port depicted. If a port is not  
10 provided, the upgrade module may, alternatively, be hard-wired to the simple decompression box 302.

As represented generally at 304, the digital data set of output wires of the simple decompression box 302 will preferably output error corrected and decrypted data to the  
15 upgrade module 300. The second set of wires, providing the interface connection, allows the microprocessor in the upgrade module 300 to communicate with the microprocessor of the simple decompression box 302. In this manner, the video circuitry of the upgrade module 300 and the simple decompression box 302 may maintain  
20 synchronization. The third set of wires, providing the decompressed video output, provide the upgrade module 300 with a decompressed video signal to manipulate. The fourth set of wires, comprising the video input set, allows the  
25 simple decompression box 302 to accept a video signal that is a combined text, graphics, and video signal.

Figure 9a further shows the CATV input 306, video input 308, and video and audio outputs 310, 312, as part of the simple decompression box 302. This embodiment  
30 reduces the component cost of upgrade module 300, and thus, is preferred. The upgrade module 300 may simply be a cartridge (not shown) insertable into the simple

decompression box 302. Alternatively, as shown in commonly numbered Figure 9b, the CATV input 306, video input 308 and video and audio outputs 310, 312 may be included as part of the upgrade module 300. In this  
5 embodiment, the simple decompression box 302 is primarily used for decompressing the video.

Referring to Figure 10, the upgrade module 300 preferably includes the following circuitry: a video graphics and text demultiplexer 314; a text and graphics video plane  
10 combiner 316; a run length graphics decompressor 318; and, a run length compressed graphics memory 320 (nonvolatile RAM, ROM, EPROM, or EEPROM). By means of communications through the multiwire connection between the upgrade module 300 and the simple decompression box  
15 302, compressed video and control signals may be demultiplexed by the demultiplexer 314 within the upgrade module 300. The run length graphics decompressor 318, through communications with the run length compressed graphics RAM 320, permits decompression of the input  
20 compressed video signal. The text and graphics video plane combiner 316 allows demultiplexed and decompressed signals to be output, through the simple decompression box 302, to a subscriber's television 222 showing both video and overlay menus with text.

25 Figure 10 shows the elements of a simple decompression box 302 (numbered commonly with the elements of the set top terminal 220 depicted in Figure 4) with the upgrade module 300 described above. Generated menus and video are combined in the combiner 316 and  
30 output to an antitaping encoder 619. Any method of antitaping encoding known by those skilled in the art may be used with the present invention.

Figure 10 also depicts an expansion card 320 and an expansion card interface 320 for receiving the card 320. In addition, error correction circuitry 324 is shown receiving the demodulated signal, prior to demultiplexing the signal.

5 The enhanced functionality of the upgrade module 300 may alternatively be included on the expansion card 320. In this embodiment, the upgrade module 300 becomes an internal component of the simple decompression box 302 and internally upgrades the box 302 to include menu  
10 generation capability without using an external hardware upgrade module 300. Other variations in the upgrade module 300 configuration are also possible.

15 b. Upstream Data Transmission Hardware

Figure 11 shows a preferred set top terminal 220 that includes a data receiver 332 and a data transmitter 344. The data transmitter 344 provides upstream data communications capability between the set top terminal 220 and the cable  
20 headend 208. Upstream data transmissions are accomplished using the polling system described with reference to Figures 7a and 7b above, and, in particular, using a data transmitter 344. Both receiver 332 and transmitter 344 may be built into the set top terminal 220 itself or added  
25 through an upgrade module 300. Regardless of the specific hardware configuration, the set top terminal's data transmission capabilities may be accomplished using the hardware shown in Figure 11.

30 Figure 11 shows RF signals, depicted at 330, being received at by a data receiver 332 and tuner 603 working in unison. Both of these devices are interfaced with the microprocessor 602, which receives inputs, depicted at 338, from the subscriber, either through the set top terminal's

keypad 645 or remote control unit 900. All cable signals intended for reception on the subscriber's TV are accessed by the tuner 603 and subsequently processed by the processing circuitry 340. This processing circuitry 340 typically includes additional components for descrambling, demodulation, volume control and remodulation on a Channel 3 or 4 TV carrier.

Data targeted to individual set top terminals 220 is received by the data receiver 332 according to each set top terminal's specific address or ID (e.g. set top ID 928, 928'). In this way, each addressable set top terminal 220 only receives its own data. The data receiver 332 may receive set top terminal specific data in the information field of the program control information signal frame described with reference to Figure 7a or on a separate data carrier located at a convenient frequency in the incoming spectrum.

Any received data includes information regarding channels and programs available for selection. The subscriber may enter a series of commands using the keypad 645 or remote control 900 in order to choose a channel or program. Upon receipt of such commands, the set top terminal's microprocessor 602 instructs the tuner 603 to tune to the proper frequency of the channel or program desired and subsequently instructs the processing circuitry 340 to begin descrambling of this channel or program.

Upon selection of a channel or program, the microprocessor 602 stores any selection information in local memory for later data transmission back to the cable headend 208. Typically, the data transmitter 344 operates in the return frequency band between 5 and 30 MHz. In an alternative embodiment, the frequency band of 10 to 15 MHz may be used. Regardless, however, of the frequency band

used, the data transmitter 344 sends information to the cable headend 208 or network controller 214 in the information field of the frame described with reference to figure 7b. Those skilled in the art will recognize that a number of variations and combinations of the above-described set top terminal 220 hardware components may be used to accomplish upstream data transmissions.

c. Hardware Upgrades

In order to enhance a set top terminal's 220 functionality, the following hardware upgrades may be used: (1) a Level A interactive unit, (2) a Level B interactive unit, (3) a Level C interactive unit with compact disc capability, (4) a Level D digital radio tuner for separate room use, and (5) a Level E information download unit. Each of these upgrades is connected to the set top terminal 220 unit through the upgrade port 662 described earlier.

Level A, B and C hardware upgrades have similar hardware components. Figure 12a diagrams the basic components of the Level A, B and C hardware upgrades, indicated generally at 100. The figure diagrams the interaction between the hardware upgrades 100 and the set top terminal's 220 basic components. As seen in the figure, CATV input signals are received by the set top terminal 220 using a tuner 603 and various receiver components described above (but denoted generally at 601 in Figures 12a and 12b). The set top terminal's microprocessor coordinates all CATV signal reception and also interacts with various upstream data transmission components 604, which have been described above.

The Level A, B and C hardware upgrades 100 each include a microprocessor 104, interactive software 106, processing circuitry 108, bubble memory 112, and a long-

term memory device 116. In addition to these basic components, the Level B hardware upgrade makes use of an additional telephone modem 120, while the Level C hardware upgrade makes use of an additional CD-ROM storage device

5 122.

Along with their basic components, the Level A, B and C hardware upgrades 100 each use their own interactive software 106. This software may be used to provide the enhanced functional capabilities described below. The Level

10 A, B and C hardware upgrades also make use of processing circuitry 108, which allows the set top terminal 220 to pass the subscriber's interactive input to the Level A, B and C hardware upgrades 100 for interpretation. These commands are passed through the interface linking the set top

15 terminal's microprocessor with the microprocessor of the Level A, B and C hardware upgrades 100. In this way, subscriber inputs, entered through the set top terminal keypad or remote control, can be transferred to any of the hardware upgrades for processing and responses generated

20 therein can then be sent back to the set top terminal 220 for display. In the preferred embodiment the IR commands are transferred from set top terminal to hardware upgrade.

The Level A, B and C hardware upgrades 100 also include a long-term memory component or device 116 that

25 allows each hardware upgrade to internally store data used with each interactive service. Such data may include, for example, customized menu templates used by the individual interactive services. In addition, the Level A, B and C hardware upgrades include a bubble memory 112 for the

30 temporary storage of, for example, interactive questions and responses used in each particular interactive service.

The Level A interactive unit allows the subscriber to access interactive services offering additional information about programs such as quizzes, geographical facts, etc. This information may be received by the set top terminal 220 in several data formats, including using the vertical blanking interval (VBI) or the program control information signal. The Level A interactive unit enables the subscriber to engage in textual interactivity with the current television program using overlay menus. Some examples are quizzes, fast facts, more info, where in the world, products, etc, all of which provide the subscriber with an interactive question and answer capability. Although the Level A interactive capability can easily be built into the set top terminal 220, such an embodiment increases the cost of the basic set top terminal 220.

The Level B interactive unit provides the user with access to online data base services for applications such as home shopping, airline reservations, news, financial services, classified advertising, home banking, and interactive teletext services. For example, with this upgrade, a user will be able to reserve plane tickets or buy consumer electronics. The primary feature of this upgrade unit is that it allows actual transactions using two-way communications over modem with outside services. This added two-way communications capability may be with the cable headend 208 or, alternatively, over cellular networks, PCN or other communications media.

The Level C interactive unit employs a high volume local storage capacity, including compact disc or other random access digital data formats (e.g., CD-ROM 122). This unit allows use of interactive multi-media applications. Such applications include, for example, computer games, multi-



media educational software, encyclopedias, other reference volumes (e.g. Shakespeare library), etc. In the preferred embodiment, many of these applications will interact with live programming providing additional information and interactivity to the basic program feed. For example, a viewer watching a show set in a foreign country may be able to retrieve additional information, maps, economic data, as well as other information about that country that are stored on the compact disc. In the Level C applications, the upgrade hardware may closely monitor the television broadcast through additional data channels (e.g., vertical blanking interval, or other digital data encoded within live video) providing context sensitive interactivity.

Figure 12b diagrams the interaction between the set top terminal 220 and the Level D hardware upgrade, indicated generally at 130. As shown in the figure, the CATV signals are input to the set top terminal 220 through its tuner 603 and receiver components 601. As described above, the microprocessor 602 coordinates all cable television signal reception by the set top terminal 220. The Level D hardware upgrade 130 makes use of a microprocessor 132, a tuner 134, a demodulator 136, a demultiplexer 138, a decryptor 140 and an audio decompressor 142.

As shown in the figure, the set top terminal 220 and the Level D hardware upgrade 130 interact through the interface linking the respective devices. The set top terminal's microprocessor 602 instructs received signals to be transferred to the Level D hardware upgrade 130 for further processing. These received signals are input to the Level D hardware upgrade, passed through the signal path comprising the tuner 134 and other digital audio reception components (i.e., demodulator 136, demultiplexer 138,

decryptor 140 and audio decompressor 142). Through the use of the hardware as configured in Figure 12b, the subscriber can select a digital audio program for listening. The subscriber can accomplish such selection through a  
5 subscriber interface (not shown), which may exist at the set top terminal 220 or, alternatively, at the Level D hardware upgrade.

The Level D hardware upgrade allows the subscriber separate access to the digital radio channels while other  
10 programming (not necessarily radio) is being viewed on the television. Typically, this upgrade would be used for digital radio usage in a separate room from that of the television. The upgrade has a separate tuner, decompressor, and visual display. In the preferred embodiment a second remote  
15 control (which is preferably a scaled-down version of the set top terminal remote control, described below) is provided to access the digital audio system. This remote is equipped with a display.

The Level E hardware upgrade allows the subscriber to  
20 download large volumes of information from the operations center 202 or cable headend 208. The Level E hardware upgrade will enable subscribers to download data, such as books and magazines, to local storage. Primarily, the Level E hardware upgrade is an additional local storage unit (e.g.,  
25 hard disk, floppy, optical disk or magnetic cartridge). Preferably, a small portable reader, called "EveryBook™", is also provided with the upgrade to enable downloaded text to be read without the use of a TV. The portable reader is equipped with a screen.

30 The downloadable information may be text or video supplied by the operations center 202 or cable headend 208. With this upgrade, books may be downloaded and read

anywhere with the portable reader. Using this upgrade, video may be downloaded and stored in compressed form for later decompression. The video would be decompressed only at the time of viewing. Important text that the public desires immediate access may made available through this system. Text such as the President's speech, a new law, or a recent abortion decision rendered by the Supreme Court may be made immediately available.

Using a more sophisticated port, such as the SCSI port, multiple hardware upgrade units may be connected, or "daisy-chained" together, to operate simultaneously. Although these upgrade units are described separately, the units may be combined or built into the set top terminal 220. Those skilled in the art will recognize variations on such combinations of and additions to the set top terminal hardware.

d. Expansion Card Slot

In order to provide the greatest flexibility possible and prevent a set top terminal 220 from becoming outdated during the terminal's useful life, additional electronic expansion card slots have been built into the preferred embodiment. The expansion slots 665 (depicted in phantom in Figure 5b) are covered by the metal plate cover 664 as shown in Figure 5b. It is anticipated that additional memory or capabilities may be needed for certain customer features and also to update the system as the cable delivery system's capabilities increase.

In addition to providing an additional memory capability, the expansion card slot provides an easy method to upgrade the set top terminal hardware. In particular, expansion cards can be used to internally provide any of the Level A through E hardware upgrade features described above.

Such embodiments, however, use the upstream data transmission hardware, also described above (or built-in modem).

Functionally, the expansion card (not shown) may be  
5 inserted into an expansion card slot 665, causing the  
connector on the expansion card to electrically link with a  
connector on the set top terminal 220. Preferably, the frame  
of the set top terminal has a shelf or rack position to hold the  
expansion card. The connector on the set top terminal 220  
10 may simply be an electrical connection to the set top  
terminal's microprocessor and/or memory device or devices.  
Alternatively, the interface between the expansion card and  
the set top terminal 220 may be an electrical bus that allows  
the memory resources of the set top terminal 220 to be  
15 directly expanded. In this case, the expansion card itself  
contains a memory device or devices that expand the amount  
of program information or data that the set top terminal 220  
may access. Such memory devices include RAM, ROM,  
EPROM or EEPROM. In addition, the interface may be a  
20 "mailbox," which resides in the set top terminal 220 as a  
single memory location. This embodiment facilitates the  
transfer of data between the set top terminal 220 and the  
expansion card in either serial or parallel format. Such  
transfers are coordinated and controlled by the set top  
25 terminal's microprocessor 602.

The use of expansion cards lowers the cost of the set  
top terminal 220 itself, while also increasing its potential  
functionality. Thus, an expansion card may include enhanced  
functional capabilities described as part of the upgrade  
30 module discussion above and be designed to accommodate  
any hardware upgrade compatible with the set top terminal  
220.

### 3. Remote Control and Subscriber Access of Set Top Terminal

5 The subscriber can access programs televised by the system through the set top terminal 220 using a remote control 900. Figure 13a shows a two-section remote control 900 that accommodates such access. To reduce costs and make the set top terminal 220 as user friendly as possible, a standard television remote control 350, such as a Jerrold RC 10 650 remote control or the like, may be augmented by adding a new section 352 that provides the additional digital menu access and ordering functions. Figure 13a depicts the addition of menu access and cursor movement control to the remote control 900.

15 The remote control 900 has an ordering button 354 and four-way cursor movement 356 that includes a "go" button 358 and menu access buttons 360. The preferred remote control 900 operates using infrared (IR) signals, with the signals being received by the infrared (IR) sensor 630 on 20 the front of the set top terminal 220.

In the simplest embodiment, the remote 900, may be built with only cursor movement and a go button. In more sophisticated embodiments, the remote control 900 may be provided with buttons that are programmable to perform 25 specific functions for a series of entries. An intelligent or smart remote control 900 would increase both the cost and capability of the set top terminal 220 system. Using the augmented remote control 900 depicted in Figure 13a, a subscriber can navigate the program menu system of the set 30 top terminal 220.

Figure 13b shows an alternative and preferred embodiment of the remote control 900 for use in the present invention. Standard television receiver remote control

switches or buttons 362 may be used, including volume control, channel select, power and signal source buttons, as well as other menu buttons 364, including cursor movement, cursor select, menu select, and pay television buttons arranged longitudinally on the remote control 900, as opposed to the width-wise separation, as shown in Figure 13a. The color of the buttons or the surrounding background may differ between the standard television remote control buttons 362 and the menu buttons 264 to differentiate visually between these two groups of buttons.

The width and depth of the remote control unit 900 are considerably less than the length to allow the remote control unit 900 to fit easily within a user's palm. The remote control unit 900 preferably has its center of mass balanced substantially near the longitudinal middle. This balance allows a user's thumb to naturally be placed in substantially the middle portion of the remote control unit 900, when it is picked up by a user.

Since the center of mass of the remote control unit 900 is placed substantially near the longitudinal middle of the remote control unit 900 (thereby having a user's thumb naturally fall in this same center region), the standard remote buttons 362 and menu access switches or buttons 364 most frequently accessed and depressed by a user are placed in the central region of the remote control unit 900 within easy reach of the user's thumb. Channel and volume increment and decrement buttons 366 are placed near this center of mass and longitudinal center line. The channel buttons 366 are preferably beveled in opposing directions to allow a user to feel for and press a desired button without looking down at remote 900. Similarly, the volume buttons 368 are preferably beveled in opposing directions for the same reason.

Additionally, the channel buttons 366 could have a surface texture different from those of the volume buttons 368 to allow even easier differentiation.

Also placed in the longitudinal center, within easy reach of a user's thumb, are cursor movement buttons 370 and a "go" button 372. The "go" button 372 selects an option corresponding to the placement of the cursor. As opposed to buttons, a joystick may be used with a selection on the stick, or a trackball, depressible for selecting a desired choice. The cursor buttons 370 are placed ninety degrees apart, with the "go" button 372 placed within the center of the cursor movement buttons 370, as shown in Figure 13b. The cursor movement buttons 370 are preferably beveled inwardly toward the "go" button 372 and the "go" button 372 is recessed below the level of the cursor movement buttons 370 so that it is not accidentally pressed while depressing the cursor movement buttons 370. In addition to the beveling on the cursor movement buttons 370, these buttons may also have a surface texture to allow a user to feel for and select the appropriate button without looking down at the remote 900 and directional arrows could be raised or recessed on the surface of the cursor movement buttons 370 for this same purpose.

Menu select buttons 374 are placed near buttons 370 as shown in Figure 13b. Menu select buttons 374 are preferably the largest buttons on the remote control unit 900. Menu select buttons 374 preferably have icons or other graphics imprinted on their top surface or adjacent to corresponding buttons. For example, a button for the sports major menu may contain a baseball icon. The icons represent the programming available on the particular major menu selected by the menu select buttons 374. The icons may also be raised

above the level of the menu select buttons to provide a textured surface. This textured surface would allow a user to select an appropriate menu button 374 by feel, without looking at the remote control unit 900. The icons would  
5 require substantial differences in texture, while still providing a meaningful graphic related to the associated menu.

As shown in Figure 13b, labels and icons are provided for the following major menus: movies, sports, children's  
10 programming, documentary/news, entertainment, magazines, programming guide, HDTV (high definition television), interactive TV, music, and an additional button 376 for further programming. Menu select buttons 374 may also be labeled A through J for the above programs, with the last  
15 button for all additional major menus labeled K-Z.

Although the remote control unit 900 is described with a variety of channel selection buttons, nearly all buttons from a standard remote control (section 362 buttons) could be eliminated. The present invention would allow a subscriber  
20 to use a remote control unit 900 containing only menu select buttons 374 and/or cursor movement and select buttons, 370, 374, respectively.

As used herein, "button" is contemplated to include all manner of switches or touch sensitive circuitry to activate a  
25 particular function in the remote control unit 900. Additionally, although the remote control unit 900 communicates with the set top box by means of infrared transmission, other forms of communication are contemplated, including ultra-sound, radio frequency and  
30 other electromagnetic frequency communication.



#### 4. Advanced Features and Functional Capabilities

##### a. Overview

5           In the preferred embodiment, the set top terminal 220  
will include features that are now being adopted in the  
industry, including parental controls and locks, electronic  
diagnostics and error detection, muting, on-screen volume  
control, sleep timer, recall of last selection, etc. Each of  
10 these features has a corresponding menu (or overlay menu)  
that allows on-screen customizing and activation of the  
feature.

The preferred set top terminal 220 also supports a  
number of advanced features and functional capabilities. This  
15 set top terminal 220 provides subscribers with a picture-on-  
picture capability without requiring a special television to  
support the capability. The set top terminal 220 also  
supports a program catalogue Service, which provides  
subscribers with information on all programming available at  
20 its particular subscriber location. The set top terminal 220  
further includes the capability of querying viewers to  
establish, among other things, favorite channel lists, personal  
profile data and mood information. The set top terminal 220  
allows the subscriber to view promotional menus on future  
25 programming events.

The set top terminal 220 supports additional  
capabilities using its hardware upgrades that allow  
subscribers to use other interactive services, for example, to  
engage in on-line question and answer sessions, to order and  
30 confirm airline tickets, and to access a variety of other data  
services. The set top terminal 220 makes use of a digital  
tuner as a hardware upgrade to provide subscribers with a  
digital audio capability.

The preferred set top terminal 220 may be used to control video tape machines, thereby simplifying the recording of programs. The set top terminal 220 can, in conjunction with the program delivery system, easily support high definition television (HDTV). For subscribers living in remote locations, the set top terminal 220 accommodates backyard satellite systems.

In addition to all the features that the set top terminal 220 supports with its current internal programming and upgradeability, additional features may be added or existing features increased through remote reprogramming of the set top terminal 220. Utilizing the resident operating system on the read only memory (ROM), the cable headend 208 is able to reprogram the random access memory (RAM) of the set top terminal 220. With this capability, the cable headend 208 can remotely upgrade software on the set top terminals 220.

Reprogramming will occur by using the program control information signal, with the appropriate signals sent over this signal. In an alternative embodiment, one channel is dedicated for the special programming needs. When reprogramming is to occur, the cable head end will send an interruption sequence on the program control information channel that informs the set top terminal 220 that reprogramming information is to follow.

b. Picture-On-Picture Capability

Although the preferred embodiment of the present invention decompresses one channel at a time for the viewer, users who desire a picture-on-picture capability can be provided with a set top terminal 220 have upgraded hardware components that allow two channels to be tuned and decompressed at any given time. Once two signals are available, the picture-on-picture capability can be made fully

available in the set top terminal 220, without requiring a special television.

Figure 15 diagrams one embodiment for implementing the picture-on-picture capability. Such implementation necessarily requires the use of two tuners 603, 603' and two decompressors 618, 618' so that two separate video programs may be displayed simultaneously on the subscriber's television screen. As shown in the figure, the CATV input signal is received by the set top terminal 220 and input into two separate tuners. These tuners will each tune to a separate television program, both of which will be simultaneously displayed on the subscriber's television. The two television programs are extracted from the CATV input signal by the two parallel signals paths depicted in Figure 15.

Each signal path is substantially identical (therefore the components thereof are commonly numbered, with callout numbers of the components of one path carrying the prime indicator) and thus, only one path will be described. Each signal path shown includes a tuner 603, a demodulator 606, a demultiplexor 609, a decryptor 600 and various decompression devices. As the respective signals pass through these devices, the microprocessor 602 coordinates the signal processing to produce a decrypted program signal. The decrypted program signal is further partitioned between audio, on the one hand, and video, graphics and text, on the other. The audio signals extracted are passed to an audio decompressor 612, which further processes the audio for output to the subscriber's television.

The embodiment diagramed in Figure 15 shows only single audio channels for each video channel tuned by the individual tuners. As described above, the number of audio channels will typically include four audio signals

corresponding to a single video channel. At least two of these audio signals may be used for stereo television play. Although the subscriber can view two separate video pictures simultaneously through the picture-on-picture capability, the subscriber's television can only accommodate a single audio signal at a time (or two audio signals for stereo audio reception). Thus, the set top terminal hardware shown in Figure 15 must also include a switch (not shown), which accommodates the simple switching between each audio signal or signals that correspond to one video picture or another. Such an audio switch, which is a component well known in the art, allows the subscriber to listen to the audio of one picture or the other. The video, graphics and text portion of the program signal are routed through another demultiplexor 314, which, in turn, separates all video, graphics and text of the signals. These signal parts are stored in a memory device 620 within the set top terminal 220. This memory device may be a ROM, RAM, EPROM, or EEPROM.

The microprocessor 602 initiates and coordinates further decompression of the video, graphics and text for each of the program signals. Once these signal parts are decompressed within the set top terminal 220, these components are passed to a video combiner 316. The video combiner correlates and combines the video, graphics and text of the two program signals. The video combiner outputs these two signals for display on the subscriber's television. These signals may also pass through an NTSC encoder 625 to produce analog NTSC video waveforms, which may likewise be displayed on the subscriber's television. Such display necessarily requires that each signal pass through an RF modulator 605 in order to be input into a television. In this

way, two separate RF video outputs are produced. Each video signal produced by the RF modulators has its own corresponding audio outputs produced by each audio decompressor.

5           Each video signal (and its corresponding audio signal) produced by the two tuner configuration can be simultaneously displayed on the subscriber's television, which has a picture-on-picture capability, or, alternatively, the set top terminal 220 itself can create the picture-on-picture  
10 image for display. Such display involves the scaling and repositioning of one of the video (and audio) signals so that both pictures produced can be viewed simultaneously. In so doing, the subscriber's television can display one of the pictures as a full screen display, with the other picture being  
15 displayed as a scaled and repositioned display overlaid on the full screen display. To implement such a technique, the set top terminal 220 must include the hardware components necessary to produce a picture-on-picture capability, including hardware capable of scaling, repositioning and  
20 overlaying images. Such an advanced set top terminal 220 allows the subscriber to make use of a picture-on-picture capability even though the subscriber's television cannot alone produce such a result.

c.    Program Catalogue Service

25           Referring to Figure 15 and to Figure 8, in the preferred embodiment of the present invention, program catalogue menu 1100 listing programs available on network schedules, will be available as a major menu of the type shown as 1020. In the preferred embodiment, the major program catalogue  
30 menu 1100 would offer submenus, such as network schedules for the next seven days, today's network schedules for the

next six hours, and TV program catalogue picks for the next seven days.

5 In order for the set top terminal 220 to provide a program catalogue service, the set top terminal 220 must receive information on all programming available at its particular subscriber location. This information will be sent to each set top terminal 220 as part of the program control information signal or STTCIS. The program control information signal would include, among other things, all  
10 programming scheduled for the next 7 days. This programming information would, for example, include the name of each program, the type of program, the program start time, the length of the program, the date the program will be shown, a brief description of the program and  
15 whether or not the program is closed-captioned, among other information.

All programming information sent to the set top terminal 220 for use with the program catalogue service will be stored in the set top terminal's internal memory. Upon  
20 selection of the program catalogue service by the subscriber, the microprocessor accesses the memory device during its menu generation and creation process. In this way, the programming information will be combined with the program catalogue menu or submenu template to produce the Program catalogue service. The program catalogue service may involve  
25 the use of more than one menu, especially where the network scheduling information covers time frames longer than a few days.

30 If the particular set top terminal 220 has been subscribed to the program catalogue service, the subscriber may proceed to a submenu showing schedules of programs. If the subscriber chooses the network schedule submenu 1102,

he is offered a list of network schedules to choose from. If a subscriber were to choose, for instance, HBO, an HBO-specific submenu (not shown) would appear and allow a subscriber to choose a date of interest to see what programs are available on that particular date.

d. Querying Viewer

To support a variety of services, the set top terminal 220 is capable of querying the viewer and recording viewer responses. For example, in order for the set top terminal 220 to establish a favorite channel list as shown at 1100 in Figure 16a depicting the broadcast TV menu 1112, menus querying the subscriber and allowing the subscriber to input his selection of eight favorite channels is displayed.

After querying the subscriber for a list of popular shows the terminal displays a submenu allowing the subscriber to choose one of the subscriber's favorite or popular shows for viewing. Although various embodiments of menus are possible, the goals of each are the same -- to eliminate or augment printed guides to television programs. In an alternative embodiment, a program viewing suggestion feature is available as an additional feature. This feature gives the indecisive or lazy viewer suggestions as to which programs the viewer should watch. The set top terminal 220 uses a matching algorithm to accomplish this program suggestion feature. This program suggestion feature is described in detail in co-pending patent application Serial NO. \_\_\_\_\_, entitled, REPROGRAMMABLE TERMINAL FOR SUGGESTING PROGRAMS OFFERED ON A TELEVISION PROGRAM DELIVERY SYSTEM, incorporated herein by reference.

In order for the set top terminal 220 to make decisions on which programs the subscriber should watch, the terminal

must create a personal profile for the particular viewer. From the data in the particular viewer's personal profile and the television program information available in the program control information signal, the set top terminal 220 is able to  
5 select a group of programs which the particular viewer is most likely to watch.

In order for this feature to operate, a personal profile for each viewer can be gathered by the set top terminal 220 and stored in a memory file. The personal profile consists of  
10 demographic information that may be gathered in a number of ways. The set top terminal 220 builds the personal profile for each viewer and stores the information in a memory file by viewer name. To build a personal profile in the preferred system, the viewer answers a series of questions presented  
15 on a series of menu screens. These personal profile screens request the viewer to input information such as name, sex, age, place of birth, place of lower school education, employment type, level of education, amount of television program viewing per week, and the number of shows in  
20 particular categories that the viewer watches in a given week such as, sports, movies, documentaries, sitcoms, etc. Any demographic information which will assist the set top terminal 220 in targeting advertisements to the viewer or suggesting programs may be used.

25 Once a personal profile has been created (in a particular set top terminal 220), it can be indefinitely stored in nonvolatile memory. A selection at the home menu screen 1010 (Figure 8) activates the program selection feature. Following activation of the feature, the set top terminal 220  
30 will present the viewer with a series of brief questions to determine the viewer's mood at that particular time, as shown in Figure 16b. For example, the first mood question



screen 1114 may ask the viewer to select whether the viewer desires a short (30 minute), medium (30-60 minute), or long (60 plus minute) program selection. The second mood question screen 1116 requests the viewer to select between a  
5 serious program, a thoughtful program, or a light program, as shown in Figure 16c. And the third mood question screen 1118 requests whether the user desires a passive program or an active program, as shown in Figure 16d. The viewer makes a selection in each question menu, utilizing the cursor  
10 movement keys and "go" button on the remote control unit 900.

After the viewer has responded to the mood question menus which determine his mood, the set top terminal 220 uses the personal profile information and mood information  
15 to find the best programming matches for the viewer. The set top terminal 220 displays an offering of several suggested programs to the viewer. With this program selection feature, the set top terminal 220 can intelligently assist the specific viewer in selecting a television program.

20 The personal profile information may also be used in targeting advertisements. In the preferred embodiment, the network controller 214 can target specific advertisements to individual cable distribution network nodes or, alternatively, to individual subscribers. In order to accomplish the  
25 advertisement targeting capability, the network controller 214 transmits packages of advertisements to the cable distribution network nodes or subscribers for eventual display on the set top terminal 220. When the video that the subscriber is watching nears a break for a commercial, a  
30 specific advertisement or set of advertisements is specifically targeted to a particular set top terminal 220 based on the personal profile information described above. Although the

network controller 214 is the component in the program delivery system which provides this targeting capability, the set top terminal 220 accommodates transparent channel switches to display the targeted advertisement. In this way, although the subscriber thinks that the set top terminal 220 is tuned to a specific channel, an advertisement from another channel is displayed on the subscriber's television.

The hardware required to accommodate such transparent channel switching capabilities are shown in Figures 17a and 17b. Figure 17a shows the set top terminal hardware components which accommodate channel switching within a single 6 MHz channel bandwidth. These components include a tuner 603, a demodulator 606, a demultiplexer 609, a multiplexer 400, a decompressor 622, a microprocessor 602, and local memory M. The tuner 603 operates by tuning to a specific 6 MHz bandwidth which includes the displayed video and a number of channels carrying advertisements. The demodulator 606 processes these signals and sends them to the demultiplexer 609, which converts the received signal into separate program and advertisement signals. During this processing, the microprocessor 602 coordinates the demultiplexing of the programming signals. Once the video signal pauses for a commercial break, the microprocessor 602 instructs the multiplexer 400 to select the advertisement or advertisements for decompression and subsequent display on the subscriber's television. This hardware configuration allows the set top terminal 220 to switch between channels within the 6 MHz bandwidth and display various advertisements for viewing, regardless of the video currently being watched by the subscriber.

Where a targeted advertisement falls outside the tuned 6 MHz bandwidth containing the video that the subscriber is currently watching, the hardware configuration shown in Figure 17b is used. In this configuration, the microprocessor  
5 602 instructs the tuner 603 to retune to another 6 MHz channel bandwidth, as represented by bi-directional arrow A.

Working together, the microprocessor 602 and tuner 603 allow targeted advertisements, which have been transmitted in another 6 MHz bandwidth, to be tuned with  
10 minimal acquisition time and delay. In particular, this configuration allows the set top terminal 220 to tune outside a given 6 MHz bandwidth (to another 6 MHz bandwidth) in order to select a targeted advertisement for display. This alternative embodiment may require the use of a full screen  
15 mask in order to minimize any annoying screen rolling during the tuning process. The masking is intended to cover any glitches which would otherwise be displayed during the acquisition time (e.g., 0.5 seconds) for retuning to another 6 MHz channel bandwidth.

Where the acquisition time or delay becomes unreasonable, an alternative embodiment (not depicted) can include the use of two tuners similar to the configuration used above for the picture-on-picture capability. This alternative configuration using two tuners trades an increased  
20 cost for lower acquisition times. Those skilled in the art will recognize a number of other configurations of set top terminal hardware that will accommodate a transparent channel switching feature. A more detailed description of target advertising and channel switching is provided in  
25 patent application Serial No. \_\_\_\_\_, entitled, NETWORK CONTROLLER FOR CABLE TELEVISION DELIVERY SYSTEM, incorporated herein by reference.  
30

e. Promotional Menus

Figure 18 depicts the use of a promotional menu 1120 used to sell subscriptions to services in the system 200. This promotional menu is tailored to Level B interactive services which include a variety of on-line type services such as Prodigy, Yellow Pages, Airline Reservations, etc. A similar menu is used for Level A interactive services that offers subscribers additional information about programs such as quizzes, geographical facts, etc. Such information may be received by the set top terminal 220 in several data formats, including in the vertical blanking interval (VBI) and in the program control information signal.

Other promotion menus similar to menu 1120 may be used for the Level C interactive services. The Level C interactive services utilize local storage such as CD technology (e.g., 122) to offer an enormous range of multi-media experiences. The Level C interactive services require a hardware upgrade as described earlier. Specially adopted CD-I and CD-ROM 122 units are used for this service.

Typically, promotional menus may be generated when a subscriber selects a nonexistent channel, creating a virtual channel. Such virtual channels do not require any additional bandwidth since these channels do not carry any of the data required to create a promotional menu. Instead, when the subscriber selects a channel that does not exist (e.g., Channel 166), a virtual channel is created using data sent to the set top terminal in a number of ways. For example, the data may be sent in the vertical blanking interval (VBI) of another channel, out-of-band, or with the menu information sent from the headend 208 in the set top terminal control information stream (STTCIS). The data will be used to create graphics stored locally at the set top terminal 220 as an NTSC video

signal which may be displayed on the subscriber's television. In this way, a promotional menu may be drawn and a virtual channel is created. This capability simply provides the set top terminal 220 with the ability to display a promotional menu or graphics display whenever a nonexistent channel is selected by the subscriber.

f. Other Interactive Services

Figures 19a and 19b show menus (1130 and 1132, respectively) that are available using the interactive Level A services. Referring to Figure 19a, when interactive Levels A services are available for a television program, the system will display an interactive logo 1134 consisting of the letter "I" and two arrows with semicircular tails. In the preferred embodiment, the set top terminal 220 will place the interactive logo on the television screen as an overlay menu. In the preferred embodiment, the set top terminal 220 will detect that there is data or information available about a television program which can be displayed to a subscriber using the interactive service. When the set top terminal 220 senses that there is interactive information available, it will generate the interactive logo overlay menu 1134 and place it on the television screen. For example, the set top terminal 220 will detect that information on a television program is being sent in the vertical blanking interval (VBI) and generate an interactive logo overlay menu 1134 which will appear on the subscriber's television screen for approximately fifteen seconds during each ten minute interval of programming. Similarly, the set top terminal 220 can sense that the programming has closed caption information available and place a closed caption logo on the screen.

Referring to Figure 19b, when the subscriber sees the interactive logo 1134 on the television screen, the subscriber

is made aware of the fact that interactive services are available in conjunction with his television program. If the subscriber presses the interactive remote control button, another overlay menu 1133 will be generated by the set top terminal 220 and placed on the screen. This overlay menu 1133 is shown in Figure 19b being overlaid on an interactive television program. From this menu 1133, the subscriber may select a variety of different types of textual interactivity with the current television program, as at 1134, including quizzes, fast facts, more info, where in the world, products, etc. At any time during the interactive submenus, the user may return to the television program without interactive features.

Another submenu 1136 gives additional information related to the television program to the viewer in textual form in the lower half of the screen. In Figure 19b, the submenu 1136 shows the available interactive options for the subcategory "quiz." In this interactive subcategory, the user is presented with questions and a series of possible answers. If the subscriber desires, the subscriber selects one of the answers to the quiz question. After the selection, the set top terminal 220 sequences to another menu. The set top terminal 220 sequences to the interactive quiz answers submenu which informs the subscriber whether the correct answer was or was not chosen. Subsequently, another submenu would show correctly or incorrectly answered quiz question.

Figure 20a is an example of a submenu for Level B interactive services. From this menu screen 1141, any of a number of on-line data services could be accessed. One service, the airline reservations selection 1142, has been chosen by the subscriber on this menu.

In selecting airline reservations, the subscriber encounters a sequence of menus as for any on-line data service. Referring to Figure 20b, the subscriber is typically shown a submenu, such as submenu 1144, for the data service offering various options. In each of these submenus related to a data service, the subscriber is able to exit, returning to the home menu 1010 or regular cable TV.

Figure 20b, the airline information and reservation submenu 1144, allows a subscriber to view six available flights. A subscriber may select one of the flights to check on its availability. Another similar submenu allows a subscriber to enter the month, day and year for the availability date desired. In this submenu, the subscriber is offered the option of correcting any errors in the entered information.

Figure 20c is another airline submenu 1150 that allows a subscriber to view remaining seats available on a flight, enabling the selection of a seat assignment. This interactive submenu 1150 is an example of how information may be graphically shown to a subscriber using a portion of the menu and different coloring schemes. In this interactive menu, the lower half of the screen 1152 shows the passenger compartment of an airplane with all the seat locations graphically represented by square blocks. By coloring the available seat locations in blue and the unavailable seat locations in a different color, the menu can present a great deal of information in a limited amount of space. This graphic presentation of information for the interactive on-line data services is an important method of visually displaying large amounts of information to the subscriber.

Referring to Figure 20d, another submenu 1156 allows the subscriber to choose a one-way or round-trip ticket, to confirm reservations and to charge an airline ticket by credit

card, choosing the appropriate strip menu on the lower part of the screen. In this particular menu 1156, the subscriber is charging a round-trip plane ticket on a credit card. The subscriber simply needs to enter the credit card number, expiration date, and credit card type to charge an airline ticket. Other submenus may process the subscriber's credit card charge for the airline ticket, confirm the subscriber's airline ticket purchase, and pass this information to the location where the ticket is printed.

Using the methods and hardware described, a variety of interactive services are possible. Those skilled in the art will recognize that such interactive services may be accommodated by the preferred set top terminal 220.

g. Caller ID

Using the capability of the set top terminal and a connected modem, the set top terminal is able to perform the function of caller ID. The caller ID function of the set top terminal assists the viewer in a manner similar to the caller ID function provided by telephone companies. However, the set top terminal is able to use the television as its display means to communicate to the viewer information about incoming telephone calls. Also, the strong local processing capability of the set top terminal allows the caller ID function to be much more user friendly and convenient.

If the set top terminal senses that a viewer is using the system and watching television, then the caller ID feature would automatically be activated. When the caller ID function is active, the set top terminal software will monitor incoming telephone calls to the viewer through the modem. After the set top terminal senses that the phone is ringing, signals are received on the tip and ring lines of the telephone, the system will immediately look for incoming telephone data



identifying the telephone number from which the telephone call was initiated.

5           Upon receiving the telephone number from which the call was initiated, the preferred embodiment of the caller ID compares the telephone number with a list of telephone numbers stored in memory. The list of telephone numbers stored in memory is cross referenced to a list of names, other textual data or graphics. When the set top terminal finds a match between the telephone number and a number stored  
10 in memory, the corresponding text or graphics are displayed on the television screen. For example, "GRANDMA" and a "smiley face" graphic can be flashed across the television screen using an overlay menu.

15           In this manner the viewer may see the name (and identifying icon graphics) of the person placing the call and can decide whether to activate an automatic telephone message recording system or answer the telephone call. After generating an overlay menu, the set top terminal software awaits an IR command signifying a viewer response.  
20 With the simple depression of a button on the remote control, the viewer can instruct the set top terminal to send an activation signal to the automatic telephone message system (through a set top terminal port). Thus, the viewer can continue to watch a program and know the identity of a  
25 caller without taking his or her eyes off the television. If a dumb telephone message system is used, the viewer can simply allow the telephone to ring the requisite number of rings until the telephone answering machine normally activates and answers the call.

30           In an alternative embodiment, having no stored telephone numbers, the set top terminal may just flash the incoming telephone number on the screen using an overlay

menu. In a more sophisticated embodiment, a microphone is provided in the set top terminal or remote control unit. Using the television's speakers, a remote control, and a microphone, the viewer is able to answer the telephone using the keys of the remote control without taking his or her eyes off the television screen.

h. Digital Audio Capability

Referring to Figure 21, the digital audio feature of the invention allows a subscriber to listen to CD quality audio selections through the subscriber's stereo (not shown). This can be accomplished by running cables directly from the set top terminal 220 (which may include a Level D hardware upgrade) to the subscriber's amplifier/stereo system. Alternatively, the subscriber may listen to audio selections through the subscriber's television system.

In the preferred embodiment, the digital audio feature uses a Level D hardware upgrade as a digital radio tuner. This Level D hardware upgrade enables a subscriber to use the program delivery system's digital audio signaling capability. Digital audio transmissions require much less bandwidth than that used for the transmission of a digital video signals. Thus, hundreds of digital audio programs are delivered to each set top terminal 220 in limited segments of bandwidth.

Where digital audio programs are delivered to the set top terminal 220, the Level D upgrade (shown in Figure 13b) provides the subscriber with the means to select a given digital audio program for listening. The Level D hardware upgrade makes use of a tuner 603 that is separate from the tuner 603 used by the set top terminal 220 for video display. The digital audio signal is received at the set top terminal 220 over the CATV transmission media. The set top terminal 220, in turn, routes the digital audio signal to the

components of the Level D hardware upgrade. These components may include: a tuner 603, demodulator 606, demultiplexer 609, decryptor, decompressor 622, remote control interface and microprocessor 602.

5           The Level D hardware upgrade will use its tuner 603 to tune to the specific digital audio program selected by the subscriber and subsequently demodulate, demultiplex and decrypt the digital audio signal. Upon completion of this processing, the digital audio signal will be decompressed to  
10           produce a processed digital audio signal ready to be output to the subscriber's stereo or directly to speakers.

          The Level D hardware upgrade includes ports for the digital audio signal output, which provide the necessary connections for transmission of the signal from the Level D  
15           hardware upgrade to the subscriber's stereo. In addition, the Level D hardware upgrade include a small LED display that can show the channel number of the program selected, date and time, among other display fields.

          The Level D hardware upgrade can be physically located  
20           in a different room from that of the television and set top terminal 220. Thus, the Level D hardware upgrade will have its own remote control device (not shown), albeit with less available options and keys than the set top terminal's remote control 900 described above. This Level D hardware upgrade  
25           remote control is more limited than the set top terminal's remote control 900 since the Level D remote control will be used exclusively for digital audio program selection. This limited remote control, nevertheless, includes a small LED or LCD display that is used to display the channel number of the  
30           digital audio program selected. Alternatively, the set top terminal's remote control may be programmed for use with

the Level D hardware upgrade so that an additional remote control is not required to use the digital audio feature.

Using either remote control embodiment, the subscriber accesses the Level D hardware upgrade to select a digital audio program. The remote control sends an IR command signal to the Level D hardware upgrade, instructing the unit's microprocessor 602 to initiate the selection of a given program. The desired program is processed (i.e., tuned, demultiplexed, decrypted and decompressed) as described above and transmitted to the subscriber's stereo for listening.

The selection of a digital audio program does not necessarily require interaction with the subscriber's television. Instead, all communications required to select a digital audio program may occur between a remote control and the Level D hardware upgrade. As a result, the subscriber's television need not be turned on for the digital audio capability to operate.

Alternatively, the Level D hardware upgrade can be co-located with the set top terminal 220 and the subscriber can select a digital audio program through a menu displayed on the subscriber's television. In this embodiment, the subscriber would use the set top terminal remote control to access a digital audio program selection menu.

In an alternative embodiment, the set top terminal 220 includes all the features of the Level D upgrade and, therefore, no upgrade is necessary. Those skilled in the art will recognize other alternatives that allow digital audio reception.

Figure 21 is a major menu 1160 displaying the digital audio program choices which are available for subscribers who have paid the monthly fee. In a chart format 1162, the

major menu shows the top five, ten, and forty songs available in six different categories of music. Below the chart, the system is able to provide a text message 1164 describing the particulars of the audio program selected. Using the same  
5 logos and menu format, the system can provide a text description enticing the subscriber to pay the monthly fee and join the service. For example, one menu may allow the user to test the system with a free demonstration. Another menu allows the subscriber to request additional promotional  
10 information about the system. Such menus may be used throughout the menu system. From any of the menu screens for the digital audio feature, the subscriber may return to regular cable TV with the press of a single button.

i. VCR Control

15 Referring to Figure 22, the advanced system of the set top terminal 220 is used to control video tape machines and simplify recording programs using a Guide Record feature. The set top terminal 220 has a separate output 650 for a VCR. Control signals are transmitted through the VCR output of the  
20 set top terminal 220 and input to the VCR to allow the VCR to be automatically controlled by the set top terminal 220. Using the set top terminal 220, certain programs are selected by a subscriber from menus, and the VCR will be automatically activated to record the selected program.

25 In order to accommodate the VCR control feature, the set top terminal 220 sends instructions or control signals to the VCR. Such control signals are initiated by the set top terminal's microprocessor 602 and passed to the VCR either using a separate connection or as part of the video signals  
30 processed for display on the subscriber's television. These control signals are sent directly from the advanced set top

terminal 220 to the VCR, instructing the VCR when to begin and end taping of a particular program.

5 The microprocessor 602 coordinates the dissemination of control signals sent to the VCR, storing the content of such signals in local memory. Upon nearing the time for the program to be displayed, the microprocessor 602 activates the menu generation software to display a notification menu or screen, notifying the subscriber that the program is nearing the time for display. This reminder will also request  
10 the subscriber to check whether a tape has been inserted into the VCR itself.

The subscriber can initiate the VCR control feature by accessing a VCR control submenu, which requests whether the subscriber wishes to record a program selected for future  
15 viewing. In this way the subscriber interactively enters such information on the menu screen or display using any of the hardware described above that accommodates subscriber interactive response capabilities.

In the preferred embodiment, the subscriber will use a  
20 movie library in conjunction with his VCR or other video taping machinery. The movie library is a menu selectable list of available movies. In that way, a subscriber may tape movies which are shown at inconvenient start times for later viewing. By enabling the proper features of the set top terminal 220, a  
25 subscriber can have the terminal activate the television and the VCR and perform all the functions necessary to tape a movie.

After the VCR control feature is initiated, a menu  
30 screen confirms the movie selection, start date and start time and informs the subscriber that the VCR will be automatically turned on. During this submenu, the user may return to the movie library major menu, or regular TV or cancel the movie

library order by pressing the escape button. This menu shows that the subscriber has chosen to return to regular TV. The subscriber's VCR or other video taping equipment must be connected to the set top terminal 220 for the automatic taping feature to operate.

5  
Following a program choice, a program description submenu is placed on the television screen. In addition, from this program description submenu, the viewer may choose to record the selected program on his VCR using the guide record feature. If the guide record feature is chosen, the guide record submenu 1170 shown in Figure 22 provides the subscriber with further instructions. In order for the set top terminal 220 to perform the guide record functions and operate the VCR, control signals are sent from the set top terminal 220 to the VCR via the video connection 650 or through a separate connection between the set top terminal 220 and the VCR. The VCR is capable of interpreting these control signals from the set top terminal 220 and performing the desired function (such as, activating the record feature). In the preferred embodiment, the VCR control signals are sent with the video signal and output from the output 650, as described above. Alternatively, a separate connection between the set top terminal 220 and VCR may be used.

j. HDTV Capability

25  
The set top terminal 220 and program delivery system of the preferred embodiment can easily support high definition television (HDTV). The combination of digital video, compression and no restricted bandwidth limitation per channel makes the preferred system ideal for HDTV. The greater information flow of HDTV causes no problems for the system. The menu selection system of the preferred

30

embodiment is a user friendly manner of presenting HDTV programming to the subscriber.

Figure 23 shows the integration of HDTV services into the menu-driven program delivery system. If the subscriber  
5 selects the major menu for HDTV 1032, the subscriber will receive either a description of the service with a suggestion to order the system, or a text note that the subscription is current and a listing of the currently available program selections in HDTV. If the subscriber has not paid to join the  
10 particular service, HDTV, the subscriber may be allowed to join one of the programs in progress for a limited time as a demo to entice the subscriber to order.

If a subscriber has paid the HDTV fees, the subscriber proceeds as in any other major menu screen. This particular  
15 major menu shows an example of how a follow-on or second screen may exist for the same menu. In this particular case, a second screen exists for the major menu HDTV 1032. The subscriber may access the second screen by selecting the last menu display block 1172 "Other HDTV Selections" in the  
20 lower part of the screen. Following this selection, the subscriber will be given a second screen of program selections. In this manner, any menu can have multiple screens with many program choices. This type of screen pagination on one menu allows the operations center 202  
25 packager to avoid categorizing program selections within that same menu. In an alternative embodiment, the options available to the subscriber may be scrolled on one menu screen with the text within the menu display blocks changing as the subscriber scrolls up or scrolls down. Many variations  
30 of this HDTV example can be used with the described system.



k. Backyard System

In an alternative configuration, in areas without cable services where subscribers use backyard satellite systems (TV RO) to receive packaged television services, the set top terminal 220 will include the appropriate hardware to allow connection to the satellite 206 reception equipment through port 656. In this configuration, the menu system within the set top terminal 220 will be programmed directly from the operations center 202. Additionally, an upstream communication mechanism must be in place at the subscriber's home (i.e. modem) to communicate information to the operations center.

The hardware components that allow the set top terminal 220 to operate in a backyard system typically will not be included within the set top terminal shell itself. Instead, any such components accommodating the set top terminal's interoperability with a backyard program delivery system will typically reside outside the subscriber's home. As a result, the set top terminal 220 will operate as described above, notwithstanding any change in program delivery transmission media.

The terms and descriptions used herein are set forth by way of illustration only and are not meant as limitations. Those skilled in the art will recognize that numerous variations are possible within the spirit and scope of the invention as defined in the following claims.

**CLAIMS**

What is claimed is:

1. An upgrade module for enhancing the functionality of a decompression box for use in a cable television program delivery system, the enhanced functionality using a control information stream that provides the decompression box with menu generation capability, the decompression box initially having the capability to produce decompressed video, the upgrade module comprising:
  - an interface means for providing an electronic connection to the decompression box so that the control information stream may be received from the decompression box;
  - a means for demultiplexing the control information stream into graphics and text;
  - a means for combining the text and graphics to produce a menu generation signal; and
  - a means for transferring the menu generation signal to the interface means for output to the decompression box, whereby the menu generation signal is processed for display.
2. The upgrade module of claim 1 further comprising a graphics decompressor for decompressing the graphics to produce decompressed graphics that may be used to generate menus.
3. The upgrade module of claim 1 for further providing the decompression box with a program catalogue that provides the subscriber with program schedules and descriptions, the decompression box providing the upgrade module with video signals, wherein the interface means

comprises a means for receiving the video signals from the decompression box and wherein the combining means comprises:

- 5                   a means for interpreting the text and graphics;  
                  a means for integrating the received video signals, the interpreted text and the interpreted graphics to produce the menu generation signal, whereby the menu generation signal carries data required for display of the program catalogue; and
- 10                  a means for sending the menu generation signal to the transfer means, whereby the menu generation signal is output to the decompression box for display of the program catalogue.

15       4.     The upgrade module of claim 1 for further enabling the decompression box to use promotional menus that provide the subscriber with promotional videos, text and graphics showing future events available for menu driven program selection, the decompression box providing the upgrade

20     module with video signals, wherein the interface means comprises a means for receiving the video signals from the decompression box, and wherein the combining means comprises:

- a means for interpreting the text and graphics;
- 25                  a means for integrating the received video signals, the interpreted text and the interpreted graphics to produce the menu generation signal, whereby the menu generation signal carries data required for display of the promotional menus; and
- 30                  a means for sending the menu generation signal to the transfer means, whereby the menu generation signal is output to the simple decompression box for

display of the promotional menus and the promotional videos, text and graphics.

- 5           5.     The upgrade module of claim 1, wherein the menu generation capability makes use of graphics and text stored locally within the upgrade module, and wherein the upgrade module further comprises a memory means for storing the graphics and text for use with the menu generation signal, so that the menus can be generated.
- 10
6.     The upgrade module of claim 1, wherein the interface means comprises at least one cable connector adapted for use with an upgrade port on the decompression box.
- 15
7.     The upgrade module of claim 1, wherein the decompression box has an expansion card slot, and wherein the interface means comprises at least one card connector adapted for use with the expansion card slot in the decompression box.
- 20
8.     The upgrade module of claim 1 for further providing the decompression box with a telephone caller identification message, the decompression box having a port adapted to receive telephone signals from a telephone line, wherein the upgrade module further comprises:
- 25           a connection means for providing an electronic connection to the decompression box for receiving the telephone signals;
- a means for processing the telephone signals to produce text messages and graphics icons; and
- 30           a means for sending the text messages and graphics icons to the combining means to produce the

menu generation signal, whereby the text messages and graphics icons are used to form the menu generation signal that is transferred to the decompression box for display of the caller identification message.

5

9. The upgrade module of claim 1 for further providing the simple decompression box with video cassette recorder control capability that uses recording menus presenting selection options to a subscriber and video cassette recorder control signals sent to the decompression box, the video cassette recorder control signals corresponding to the selection options chosen by the subscriber, wherein the menu generation card further comprises:

10

15

a means for generating the recording menus;  
a means for interpreting the selection options chosen by the subscriber and received from the set top converter through the interface means;

20

a means for generating the video cassette recorder control signals based on the interpreted selection options chosen by the subscriber; and  
a means for transmitting the video cassette recorder control signals to the decompression box for instructing the video cassette recorder in recording of programs.

25

30

10. A hardware upgrade for enhancing the functionality of a set top converter in a cable television program delivery system, each set top converter having menu generation capability and a subscriber interface adapted to receive subscriber inputs, the hardware upgrade using interactive programming instructions to process interactive subscriber

inputs to produce processed interactive subscriber inputs,  
the hardware upgrade comprising:

5 an interface means for providing an electrical  
connection to the set top converter, whereby the  
interactive subscriber inputs are transferred from the  
set top converter for processing and the processed  
interactive subscriber inputs are passed to the set top  
converter for display;

10 a means for storing the interactive programming  
instructions;

a means for accessing the stored interactive  
programming instructions;

15 a microprocessing means for processing the  
interactive subscriber inputs to produce the processed  
interactive subscriber inputs based on the stored  
interactive programming instructions.

11. The hardware upgrade of claim 10, wherein the  
interface means comprises:

20 a means for receiving the subscriber inputs from  
the set top converter, wherein the received subscriber  
inputs include textual information that is used to  
produce the processed subscriber inputs; and

25 a means for transferring the processed subscriber  
inputs to the set top converter for display.

30 12. The hardware upgrade of claim 10 for use with on-line  
databases and interactive services outside of the cable  
television program delivery system, wherein the hardware  
upgrade further comprises a telephone modem adapted to  
provide communications capability with the on-line databases  
and the interactive services.

13. The hardware upgrade of claim 10 that uses digital data, wherein the hardware upgrade further comprises:

5 a high volume memory means capable of storing the digital data to produce stored digital data; and  
a means for linking the high volume memory means to the microprocessing means, wherein the stored digital data is transferred to and received from the microprocessing means.

10

14. The hardware upgrade of claim 10, wherein the set top converter has an expansion card slot, and wherein the interface means comprises at least one card connector adapted for use with the expansion card slot in the set top converter.

15

15. A hardware upgrade for enhancing the functionality of a set top converter and television display in a cable television program delivery system, each set top converter having a subscriber interface adapted to receive subscriber inputs and to display menus, the enhanced functionality allowing reception of digital audio programs, the hardware upgrade comprising:

20

25 a subscriber interface means for subscriber selection of any one of the digital audio programs using one or more of the menus displayed with the menu generation capability;

25

30 an interface means for providing an electrical connection to the set top converter, wherein the subscriber selections are passed to the set top converter for display and wherein the digital audio programs received;

30

a means for processing digital audio programs;  
and  
a means for enabling one of the digital audio  
programs for listening based on the subscriber  
5 selections.

16. The hardware upgrade of claim 15 for use with a  
frequency carrying a digital audio signal, wherein the  
processing means comprises:

10 a means for tuning to the frequency carrying the  
digital audio signal that corresponds to one of the  
digital audio programs;  
a means for demodulating the digital audio signal;  
a means for extracting one of the digital audio  
15 programs from the digital audio signal; and  
a means for decompressing the extracted digital  
audio program for output to the set top converter,  
whereby the digital audio output occurs over the  
interface means.

20 17. An upgradeable set top converter for use in a cable  
television program delivery system, the set top converter  
initially having video decompression capability and an  
expansion card slot adapted to receive a menu generation  
25 card, the set top converter upgradeable for enhanced  
functionality that provides the set top converter with menu  
generation capability using a control information stream  
received from a remote location, the upgradeable set top  
converter comprising:

30 an interface means for providing an electronic  
connection to the set top converter, whereby the



control information stream is received from the set top converter through the interface means;

5 a means, connected to the interface means, for demultiplexing the control information stream into graphics and text, whereby the control information stream is passed to the demultiplexing means from the set top converter through the interface means; and

10 an expansion card interface means for receiving the menu generation card, whereby the menu generation card upgrades the set top converter for menu generation capability.

18. The upgradeable set top converter of claim 17 further comprising a graphics decompressor for decompressing the graphics to produce decompressed graphics that may be used to generate menus.

19. An upgraded set top converter for use in a cable television program delivery system, the set top converter initially having video decompression capability and an expansion card slot, the set top converter upgraded for enhanced functionality that provides the set top converter with menu generation capability using a control information stream received from a remote location, the upgraded set top converter comprising:

an interface means for providing an electronic connection to the set top converter;

30 a means for demultiplexing the control information stream into more than one program signal component, including graphics and text, whereby the control information stream is passed to the

demultiplexing means from the set top converter through the interface means; and  
an expansion card interface means; and  
a menu generation card, electronically connected  
5 to the expansion card interface means, comprising a means for combining the text, graphics and video signals to produce a menu generation signal, whereby the menu generation signal is output through the interface means to the set top converter to be  
10 processed for display.

20. The upgraded set top converter of claim 19 further comprising a graphics decompressor for decompressing the graphics to produce decompressed graphics that may be used  
15 to generate menus.

21. The upgraded set top converter of claim 19 with the enhanced functionality further providing the set top converter with a program catalogue that provides the  
20 subscriber with program schedules and descriptions corresponding to video signals, wherein the interface means comprises a means for receiving the video signals, and wherein the combining means comprises:

a means for interpreting the text and graphics;  
25 a means for integrating the video signals, the interpreted text and the interpreted decompressed graphics to produce the menu generation signal, whereby the menu generation signal carries data required for display of the program catalogue; and  
30 a means for sending the menu generation signal to the transfer means, whereby the menu generation

signal is output to the set top converter for display of the program catalogue.

22. The upgraded set top converter of claim 19 for further  
5 enabling the set top converter to use promotional menus that  
provide the subscriber with promotional video signals, text  
and graphics showing future events available for menu driven  
program selection, wherein the interface means comprises a  
means for receiving the video signals, and wherein the  
10 combining means comprises:

a means for interpreting the text and graphics;  
a means for integrating the promotional video  
signals, the interpreted text and the interpreted  
graphics to produce the menu generation signal,  
15 whereby the menu generation signal carries data  
required for display of the promotional menus; and  
a means for sending the menu generation signal  
to the transfer means, whereby the menu generation  
signal is output to the set top converter for display of  
20 the promotional menus.

23. The upgraded set top converter of claim 19 for further  
providing the set top converter with a telephone caller  
identification message, the set top converter having a port  
25 adapted to receive telephone signals from a telephone line,  
wherein the menu generation card further comprises:

a connection means for providing the electronic  
connection to the set top converter, whereby the  
telephone signals are received from the set top  
30 converter; and  
a means for processing the telephone signals to  
produce text messages and graphics icons and for

5 sending the text messages and graphics icons to the combining means to produce the menu generation signal, whereby the text messages and graphics icons are used to form the menu generation signal that is transferred to the set top converter for display of the caller identification message.

10 24. The upgraded set top converter of claim 19 for further providing the set top converter with video cassette recorder control capability that uses recording menus presenting selection options to a subscriber and video cassette recorder control signals sent to the set top converter, the video cassette recorder control signals corresponding to the selection options chosen by the subscriber, wherein the menu generation card further comprises:

15 a means for generating the recording menus;  
a means for interpreting the selection options chosen by the subscriber and received from the set top converter through the interface means;

20 a means for generating the video cassette recorder control signals based on the interpreted selection options chosen by the subscriber; and  
a means for transmitting the video cassette recorder control signals to the set top converter for

25 instructing the video cassette recorder in recording of programs.

30 25. An advanced set top terminal with digital decompression and menu generation capabilities for use with a cable television program delivery system having digitally compressed program signals and a control information stream carrying menu content information, each set top

terminal stores menu content information used to generate menu displays, the advanced set top terminal comprising:

a means for storing the menu content information;

5 a means for receiving the digitally compressed program signals and the control information stream;

a first signal processing means for processing the control information stream to produce processed control information, whereby the processed control information is used to update the stored menu content information to produce updated menu content information;

10 a means for generating the menu displays using the updated menu content information, whereby the menu displays produce subscriber options for selection of other menus and television programs;

15 a means for selecting the other menus and the television programs;

20 a means for tuning to one of the digitally compressed television programs signals to produce a tuned television program signal; and

25 a second signal processing means for processing the tuned television program signal to produce a video signal and audio signal for television display and listening.

26. The advanced set top terminal of claim 25, wherein the second signal processing means comprises:

30 a means for demodulating the tuned television program signal to produce a demodulated program signal;

a means for demultiplexing the demodulated program signal to produce video signal components and audio signal components;

5 a video decompressing means for decompressing the video signal components to produce decompressed video signal components;

an audio decompressing means for decompressing the audio signal components to produce decompressed audio signal components;

10 a means for combining the decompressed video signal components with the stored menu content information for television display of the video signal; and

15 a means for producing the audio signal from the decompressed audio signal components.

27. The advanced set top terminal of claim 26 that has a picture-on-picture capability using multiple tuners, wherein the tuning means comprises more than one tuner so that the multiple tuners can produce multiple television program signals which will be overlaid over one another.

28. The advanced set top terminal of claim 26 having a program catalogue service that provides the subscriber with program schedules and descriptions, the program schedules and descriptions created from text and graphics, the text and graphics and the decompressed video derived from the control information stream, wherein the advanced set top terminal further comprises:

30 a means for interpreting the text and graphics;

a means for integrating the interpreted text, the interpreted graphics and the video signal to produce a

menu generation signal, whereby the menu generation signal carries data required for display of the program catalogue; and

5                   a means for outputting the menu generation signal for display.

29.   The advanced set top terminal of claim 26 having a promotional menu display capability that provides subscribers with promotional videos, text and graphics showing future events available for menu driven program selection, wherein text and graphics are derived from the control information stream, and wherein the advanced set top terminal further comprises:

10

15                   a means for interpreting the text and graphics;  
                    a means for integrating the interpreted text, the interpreted graphics and the decompressed video to produce a menu generation signal, whereby the menu generation signal carries data required for display of the promotional videos; and

20                   a means for outputting the menu generation signal for display.

30.   The advanced set top terminal of claim 25 capable of operating with interactive services conducted from a cable headend or other remote location, the interactive services requiring entry of interactive subscriber inputs and use of interactive programming instructions, wherein the selection means comprises:

25

30                   a subscriber interface means for entry of the interactive subscriber inputs;  
                    a means for storing the interactive programming instructions;

a means for accessing the stored interactive programming instructions;

a microprocessing means for executing the stored interactive programming instructions to produce interactive signals; and

an upstream data transmission means for transmitting the produced interactive signals to the cable headend.

10 31. The advanced set top terminal of claim 26 having a caller identification function capable of displaying a caller identification message using a menu generation signal, wherein the advanced set top terminal further comprises:

a means for receiving telephone signals;

15 a means for processing the telephone signals to produce text messages and graphics icons using the menu content information;

a means for combining the text messages and graphics icons to produce the menu generation signal carrying the caller identification message for television display; and

20 a means for preparing the menu generation signal for television display.

25 32. The advanced set top terminal of claim 25 capable of processing high definition television signals, wherein the second signal processing means comprises:

a means for interpreting the high definition television signals; and

30 a means for preparing the interpreted high definition television signals for television display.



33. The advanced set top terminal of claim 25 capable of receiving television program signals through a backyard system having backyard digital signal processing equipment, wherein the advanced set top terminal further comprises an interface means for electrically connecting the backyard digital satellite processing equipment to the first signal processing means.

34. A remote control unit for use with a set top terminal, the set top terminal capable of receiving a plurality of digitally compressed television signals and generating a plurality of menus corresponding to the digitally compressed signals, each menu corresponding to a group of related programs or a single program, the remote control unit comprising:

means, within the remote control unit, for communicating with the set-top terminal to allow selection of a desired program by a user from the plurality of menus; and,

a plurality of switches, coupled to the means for communicating, the plurality of switches including menu select switches and cursor movement switches, the cursor movement switches being capable of causing a cursor to move on a menu;

the menu select switches being capable of selecting a desired menu from the plurality of menus, the menu switches having icons representing the groups of related television signals;

the cursor movement switches located substantially at the center of mass of the remote control unit, and each cursor movement switch having an angled surface;

5                   whereby a user's thumb may easily access  
                  and depress a cursor movement switch or menu  
                  select switch and distinguish the cursor  
                  movement switches and menu select switches  
                  from the remainder of the plurality of switches  
                  without looking at the remote control unit.

10               35. The remote control unit of claim 34 wherein the  
                  plurality of switches includes two groups of switches, a  
                  standard group including the volume control and channel  
                  select switches, and a special group including the cursor  
                  movement switches and menu select switches, whereby the  
                  two groups of switches are physically separated from each  
                  other on the remote control unit by a line at or above the  
15               center of mass of the remote control unit.

                  36. The remote control unit of claim 34 further comprising  
                  a joystick for cursor movement.

20               37. The remote control unit of claim 34 further comprising  
                  a ball for cursor movement.

                  38. The remote control unit of claim 34 further comprising  
                  a rolling-depressible button for cursor movement.

25               39. An interface system with program instructions that uses  
                  button depression signals for subscriber entries for a  
                  subscriber to interface with a video and audio programming  
                  delivery system which uses digitally compressed signals, for  
30               selecting programs using a cursor on menus or menu buttons,  
                  comprising:

a portable remote control unit for accepting subscriber entries comprising:

a plurality of buttons for creating button depression signals comprising:

5 cursor movement buttons for directional movement of the cursor; and menu buttons for choosing menus;

and

10 a means for communicating button depression signals;

a set top terminal unit for selecting programs comprising:

a means for receiving the digitally compressed signal;

15 a means for decompressing the digitally compressed signal into a decompressed signal;

a means for generating menus from the decompressed signals;

20 a means for receiving the communicated button depression signals;

a processor means, connected to the receiving means, for executing the program instructions comprising:

25 a means for effecting the execution order of program instructions using the button depression signals; and

a means for sequencing through the generated menus.

30 40. A method for enhancing the functionality of a decompression box for use in a cable television program delivery system, the enhanced functionality using a control

information stream that provides the decompression box with menu generation capability, the decompression box initially having the capability to produce decompressed video, the upgrade module comprising:

- 5                    providing an electronic connection to the decompression box so that the control information stream may be received from the decompression box;
- demultiplexing the control information stream into graphics and text;
- 10                   combining the text and graphics to produce a menu generation signal; and
- transferring the menu generation signal to the decompression box, whereby the menu generation signal is processed for display.

15

41. A method for enhancing the functionality of a set top converter, each set top converter having a subscriber interface adapted to receive subscriber inputs and menu generation capability for operation in a cable television program delivery system, the enhanced functionality using interactive programming instructions to process interactive subscriber inputs, the method comprising the steps of:

- providing an electrical connection to the set top converter, whereby the interactive subscriber inputs are transferred from the set top converter for processing and the processed interactive subscriber inputs are passed to the set top converter for display;
- 25                   storing the interactive programming instructions;
- accessing the stored interactive programming instructions;
- 30                   executing the interactive programming instructions; and

5 electrically processing the interactive subscriber inputs to produce the processed interactive subscriber inputs, wherein the interactive subscriber inputs are electrically processed according to the executed interactive programming instructions.

10 42. A method for enhancing the functionality of a set top converter, each set top converter having a subscriber interface adapted to receive subscriber inputs and menu generation capability for operation in a cable television program delivery system, the enhanced functionality allowing reception of digital audio programs, the method comprising the steps of:

15 providing an electrical connection to the set top converter, wherein the subscriber inputs are passed to the set top converter for display and wherein the digital audio programs received;

20 processing the digital audio programs;  
selecting any one of the processed digital audio programs using one or more of the menus displayed with the menu generation capability; and

enabling the subscriber inputs to produce one of the digital audio programs for listening.

25 43. A method for upgrading a set top converter for use in a cable television program delivery system, the set top converter having video decompression capability and an expansion card slot adapted to receive a menu generation card, the set top converter upgradeable for enhanced  
30 functionality that provides the set top converter with menu generation capability using a control information stream

received from a remote location, the method comprising the steps of:

- providing an electronic connection to the set top converter;
- 5 demultiplexing the control information stream into graphics and text, whereby the control information stream is received from the set top converter;
- graphically decompressing the graphics to produce decompressed graphics that may be used to
- 10 generate menus; and
- connecting the menu generation card to the set top converter; and
- using the menu generation card to combine the text and decompressed graphics to produce a menu
- 15 generation signal, whereby the menu generation signal is output to the set top converter to be processed for display.

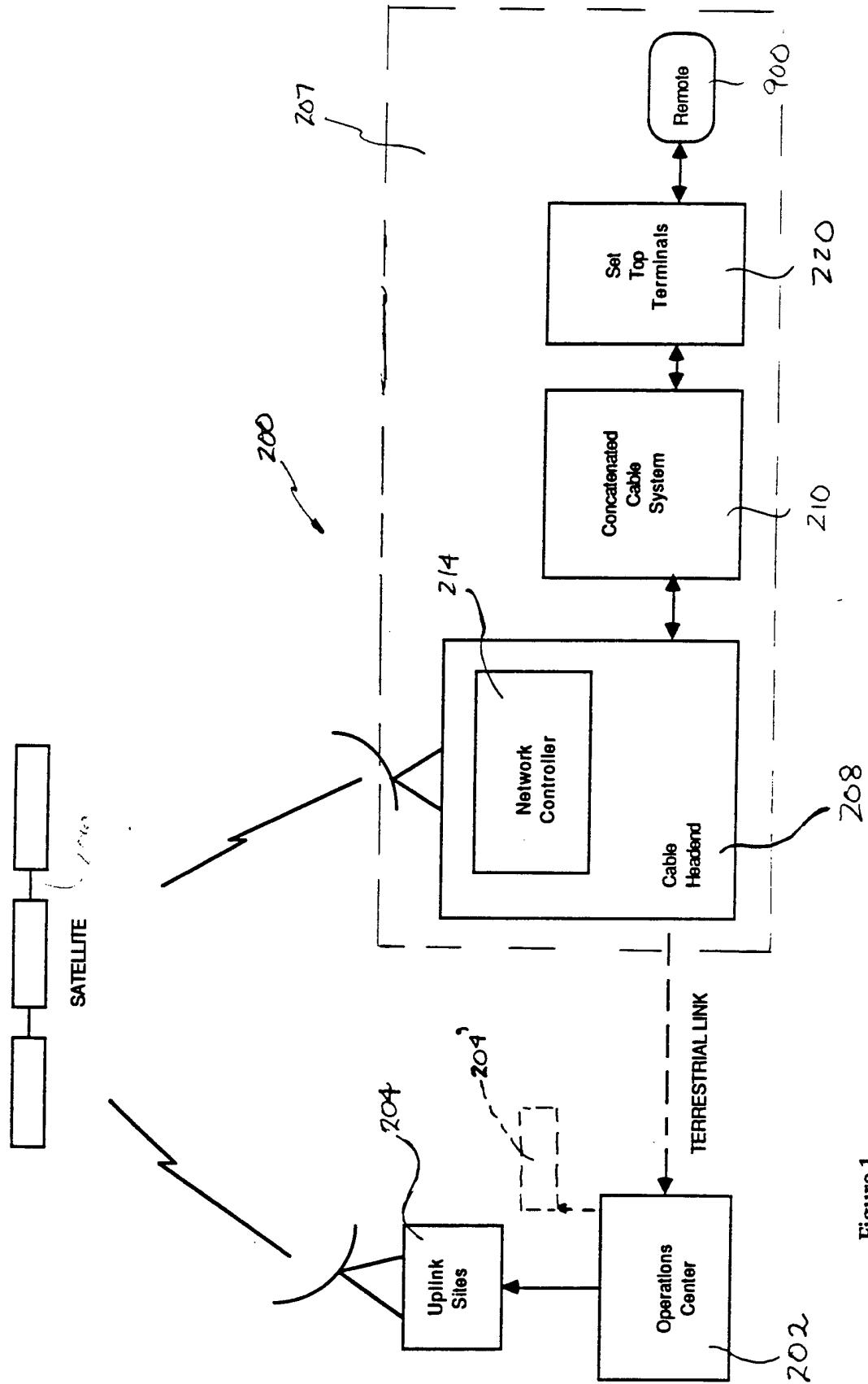
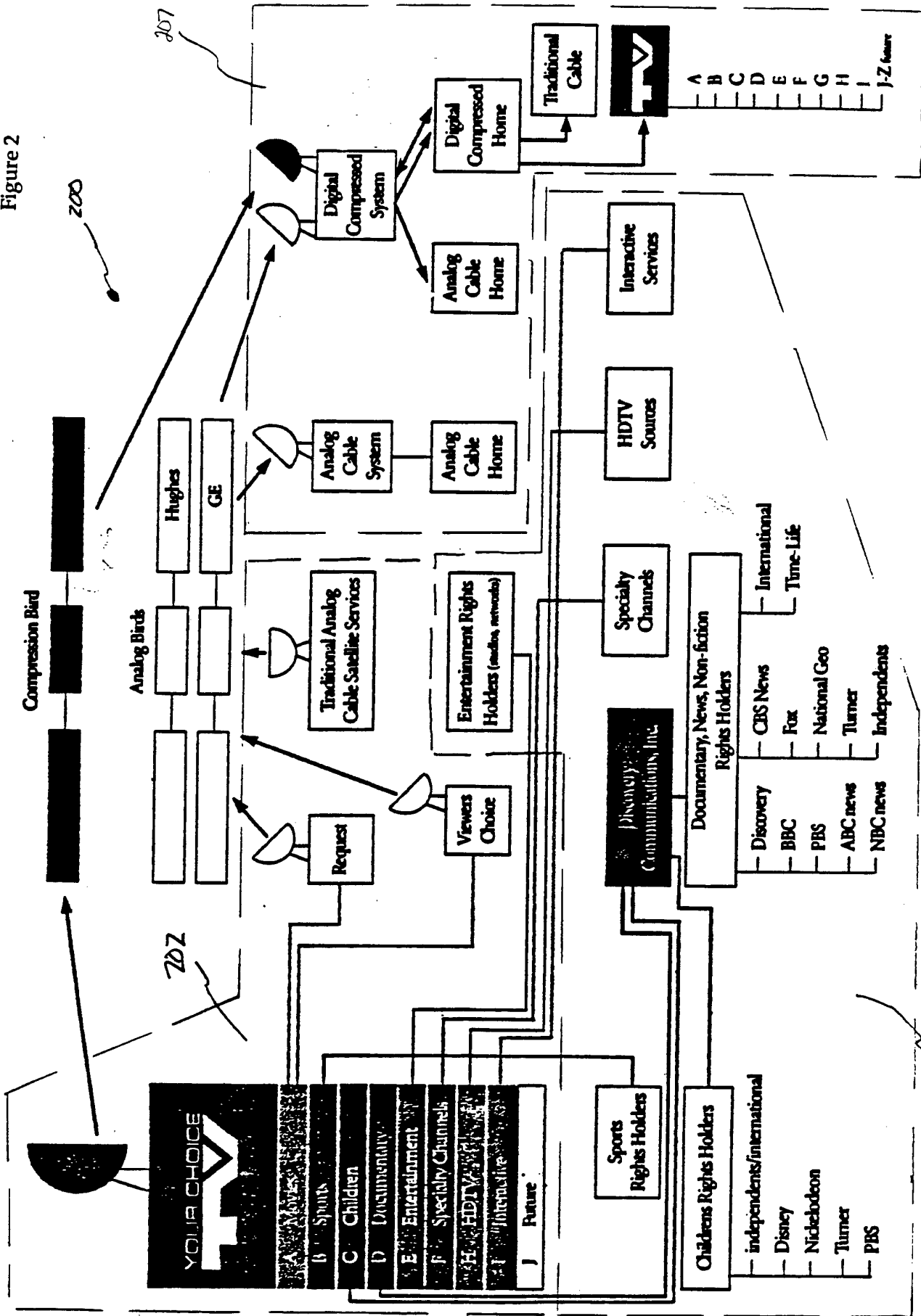

Figure 1

Figure 2



212



Figure 3

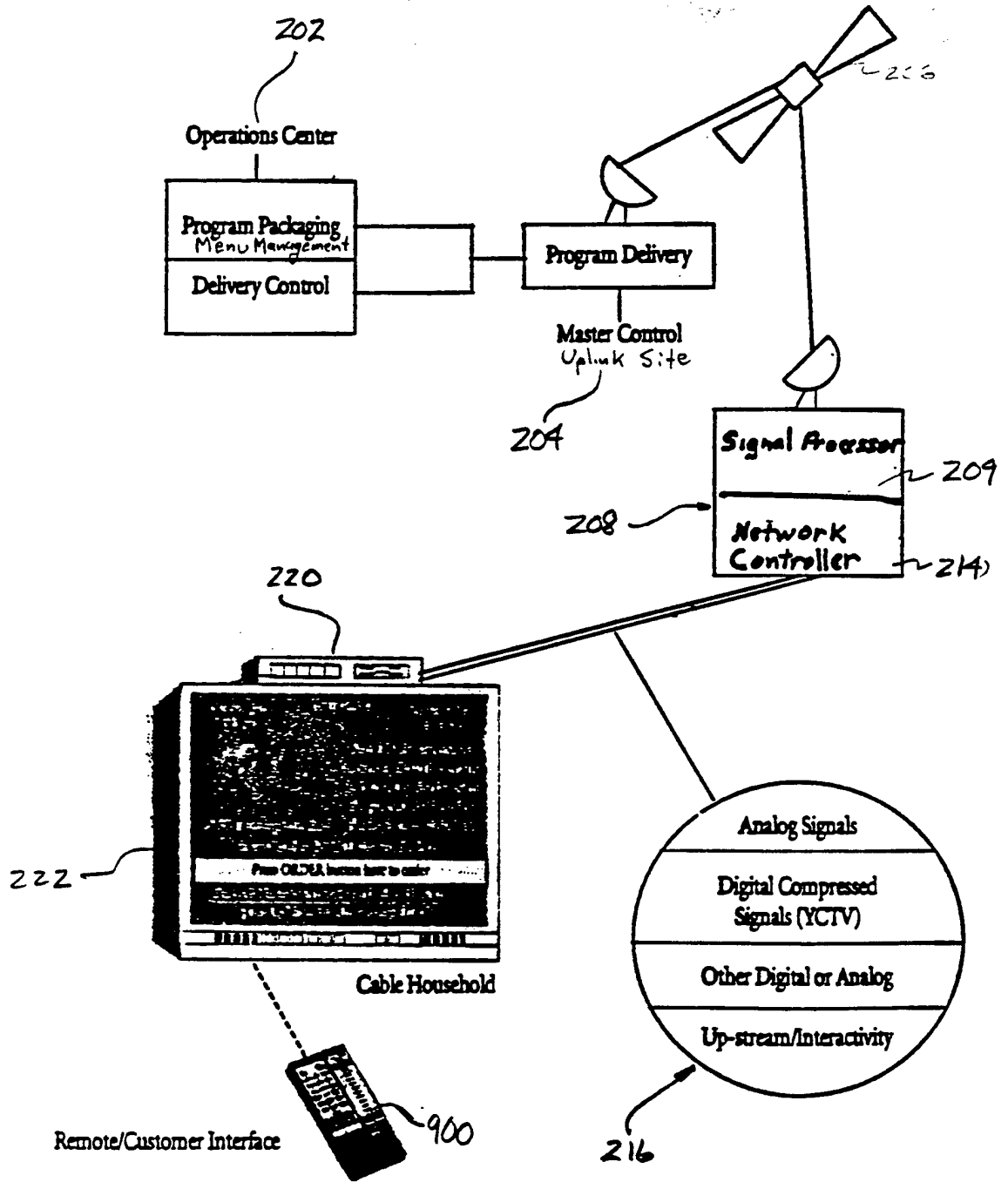

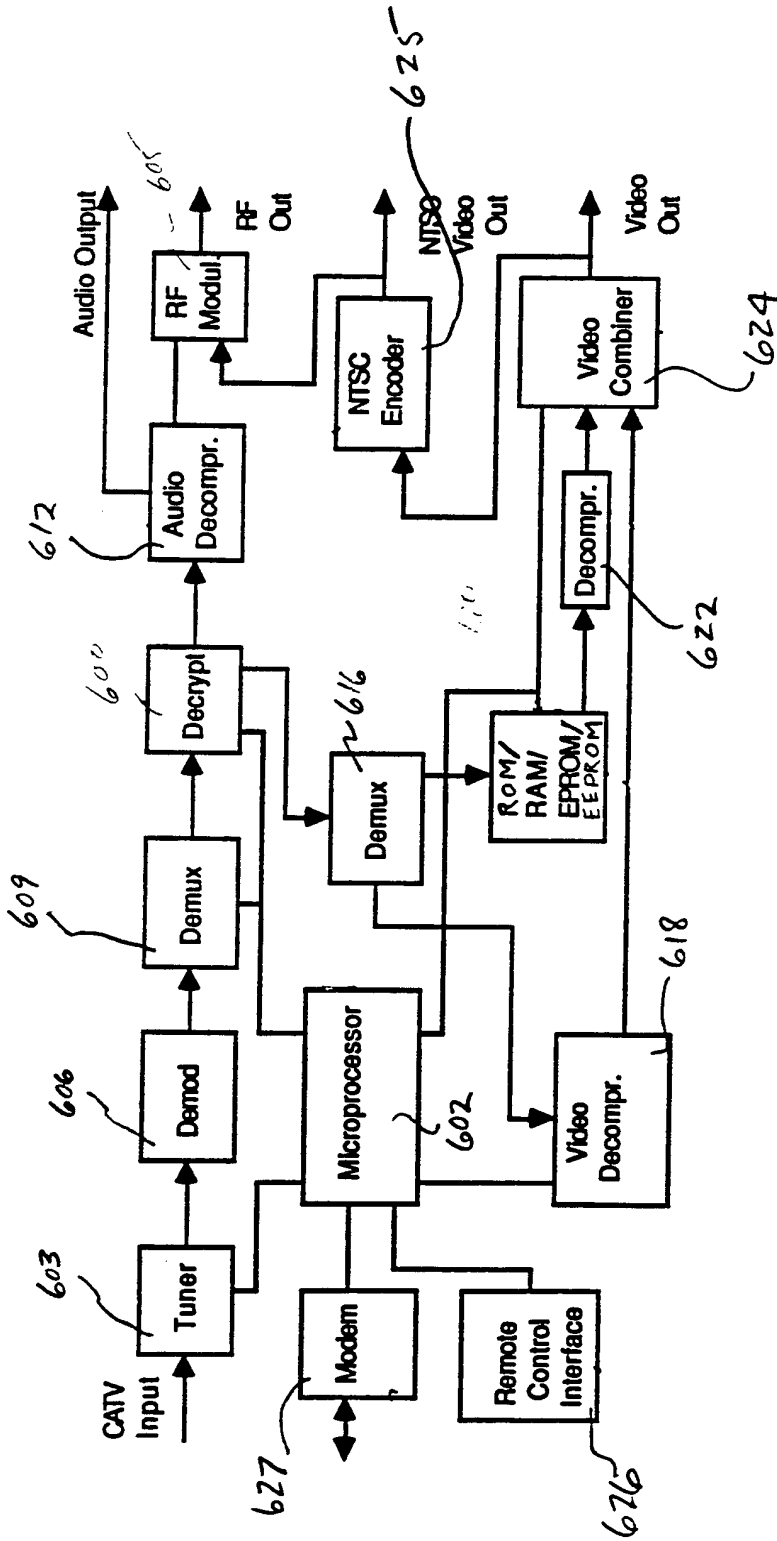
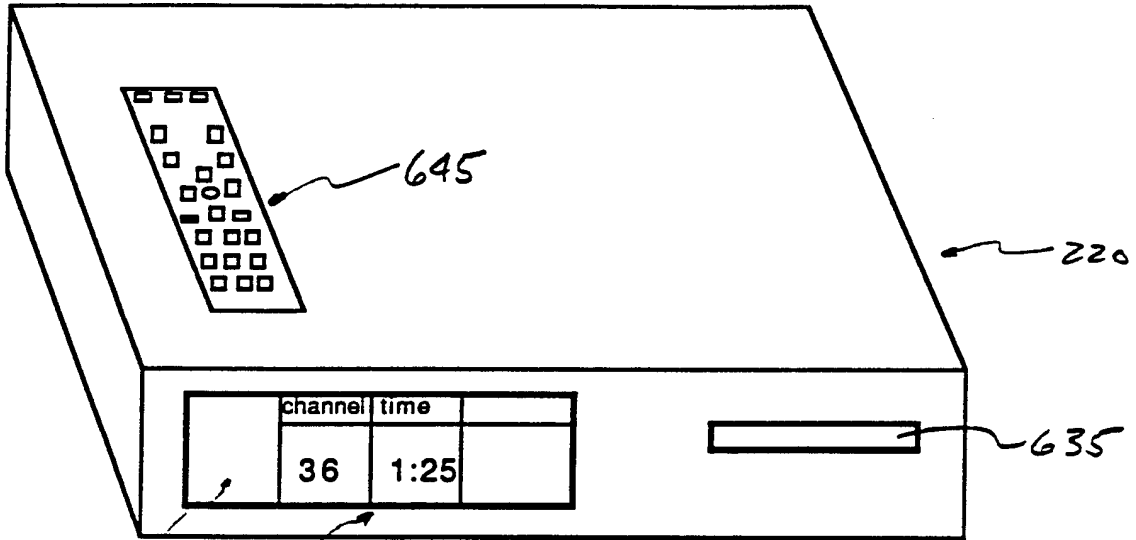
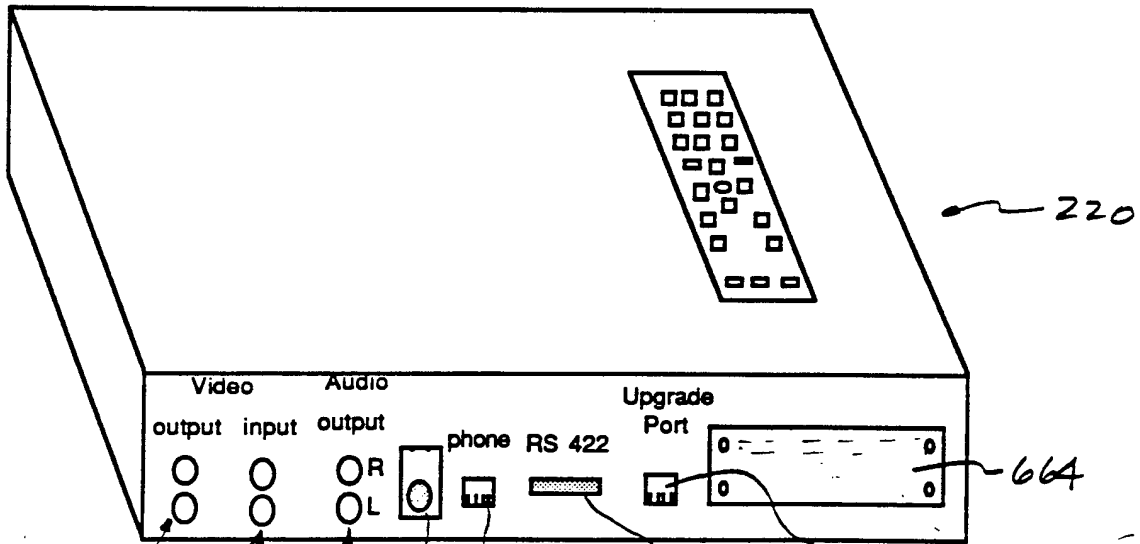

Figure 4

220



630 640 Figure 5a



650 652 654 658 660 662 Figure 5b 656

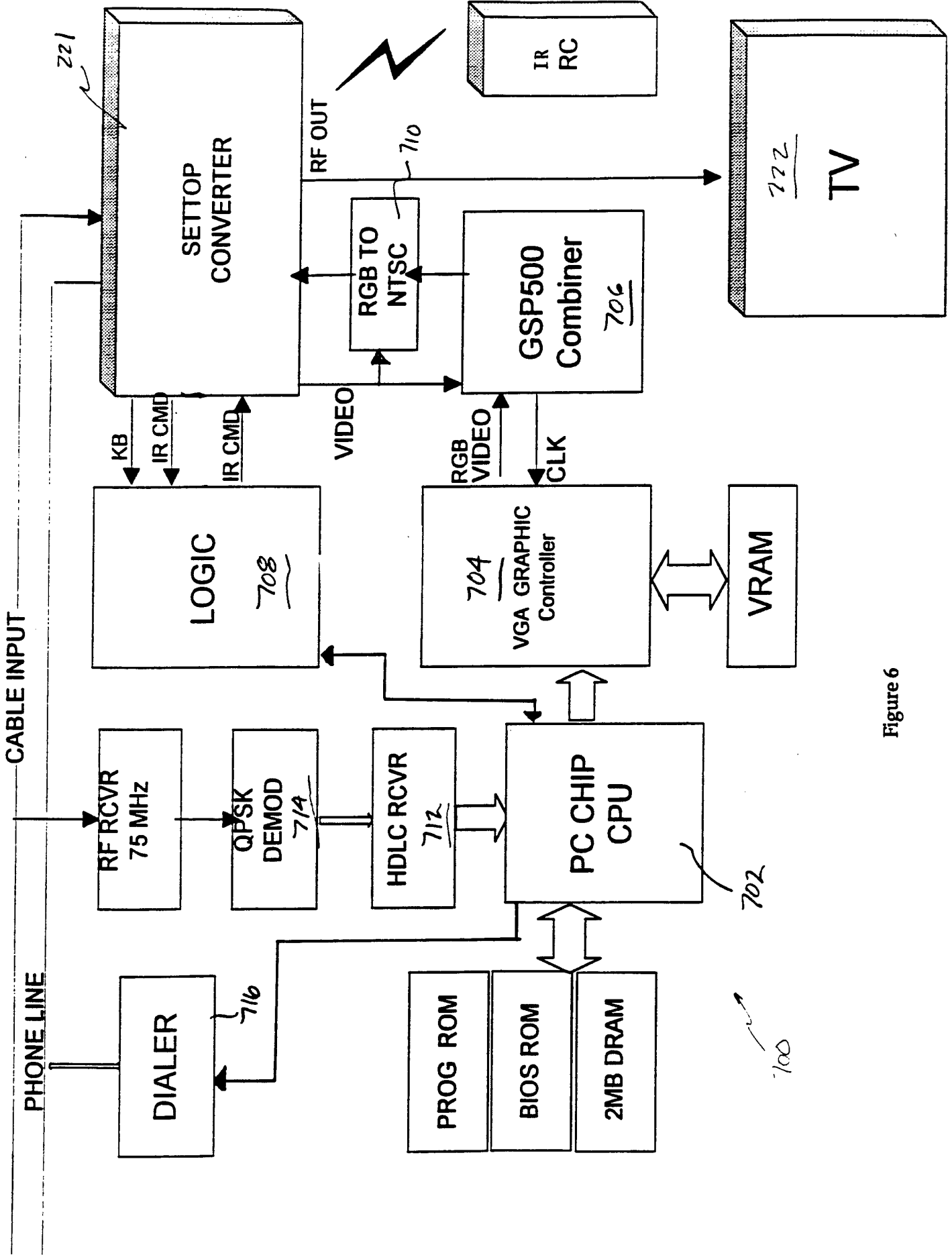

Figure 6

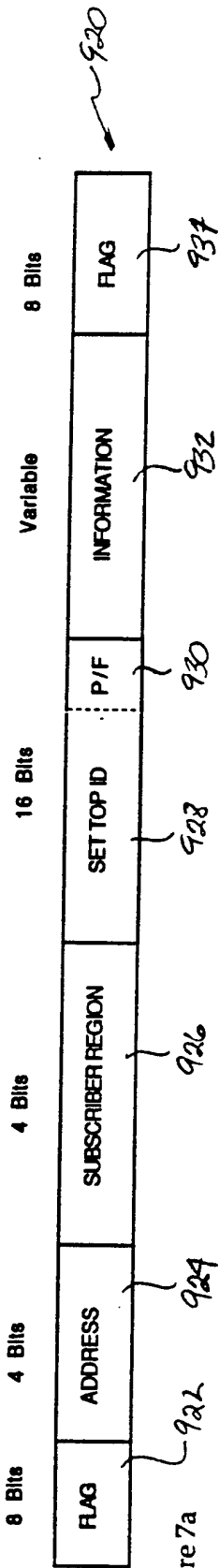

Figure 7a

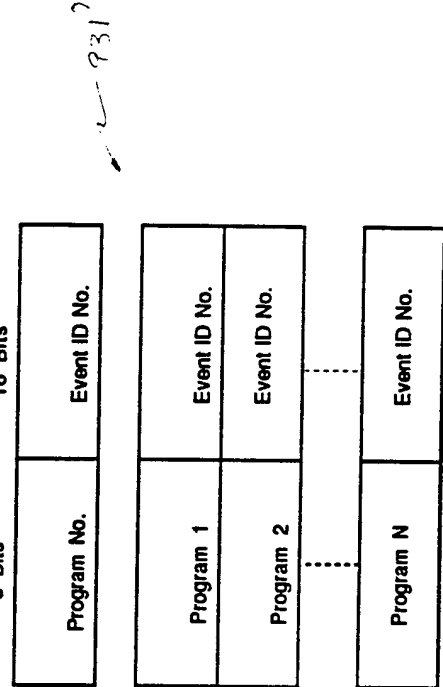
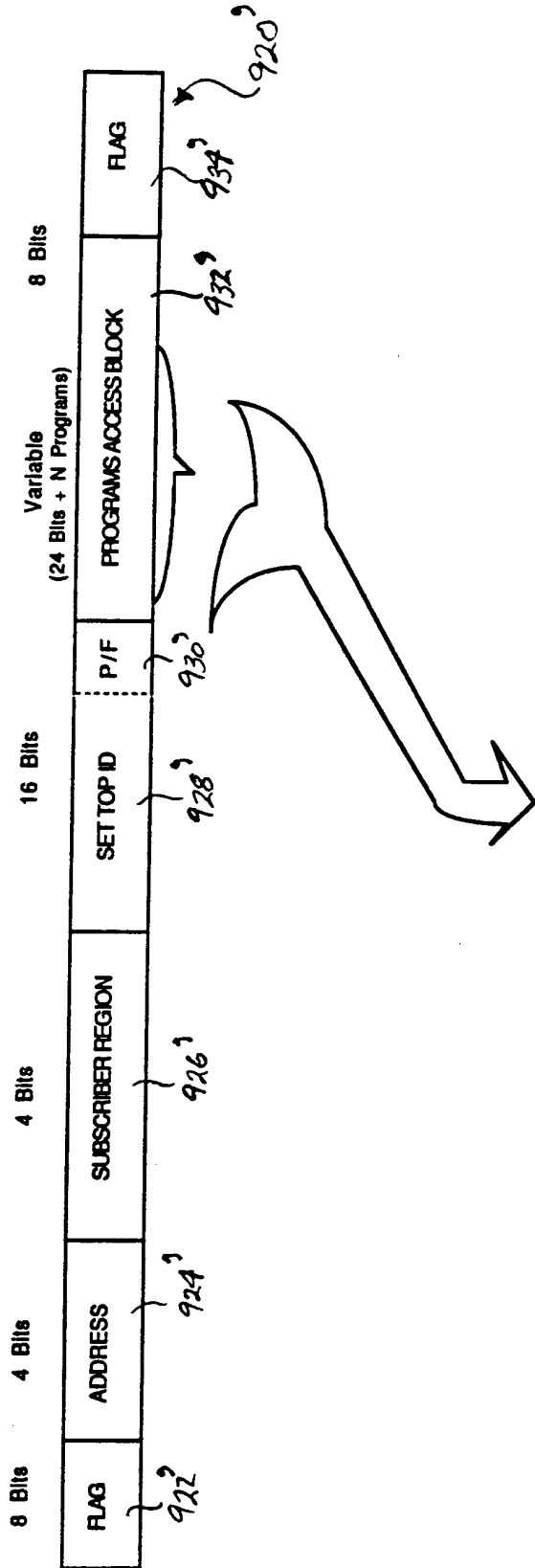

Figure 7b

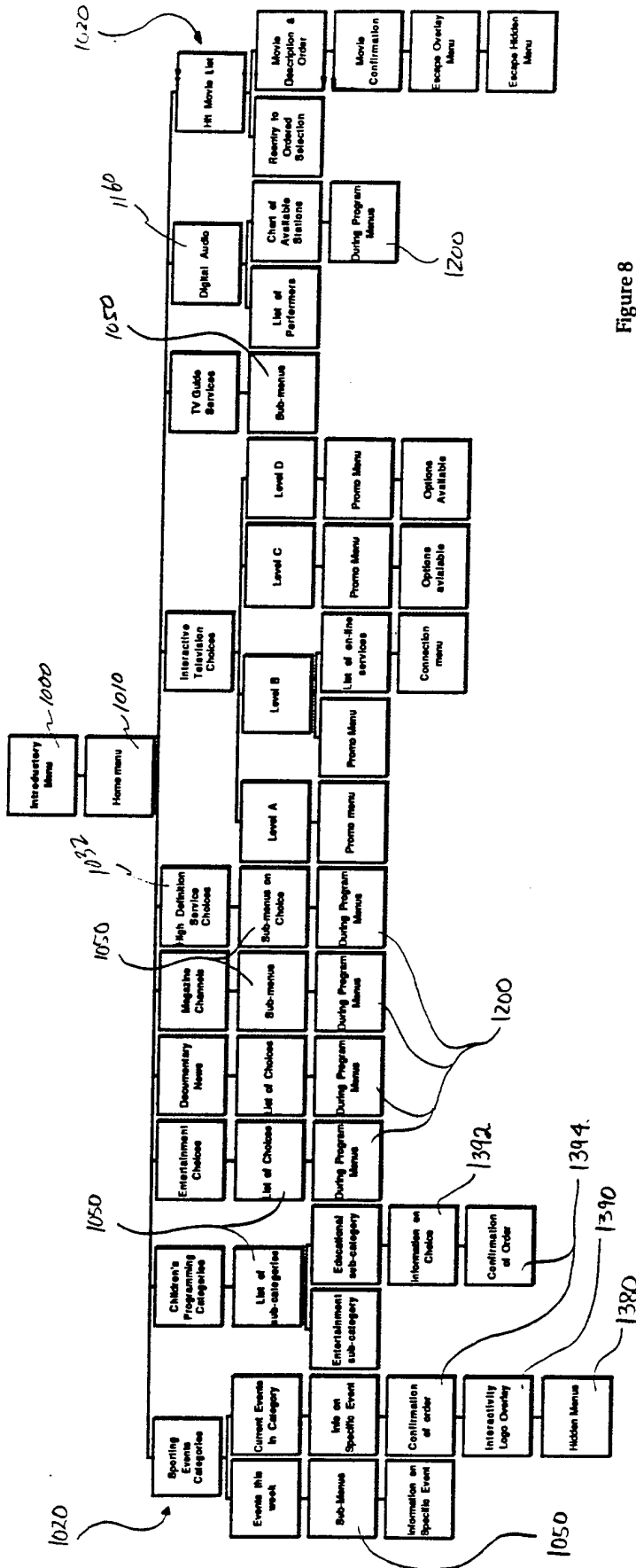

Figure 8

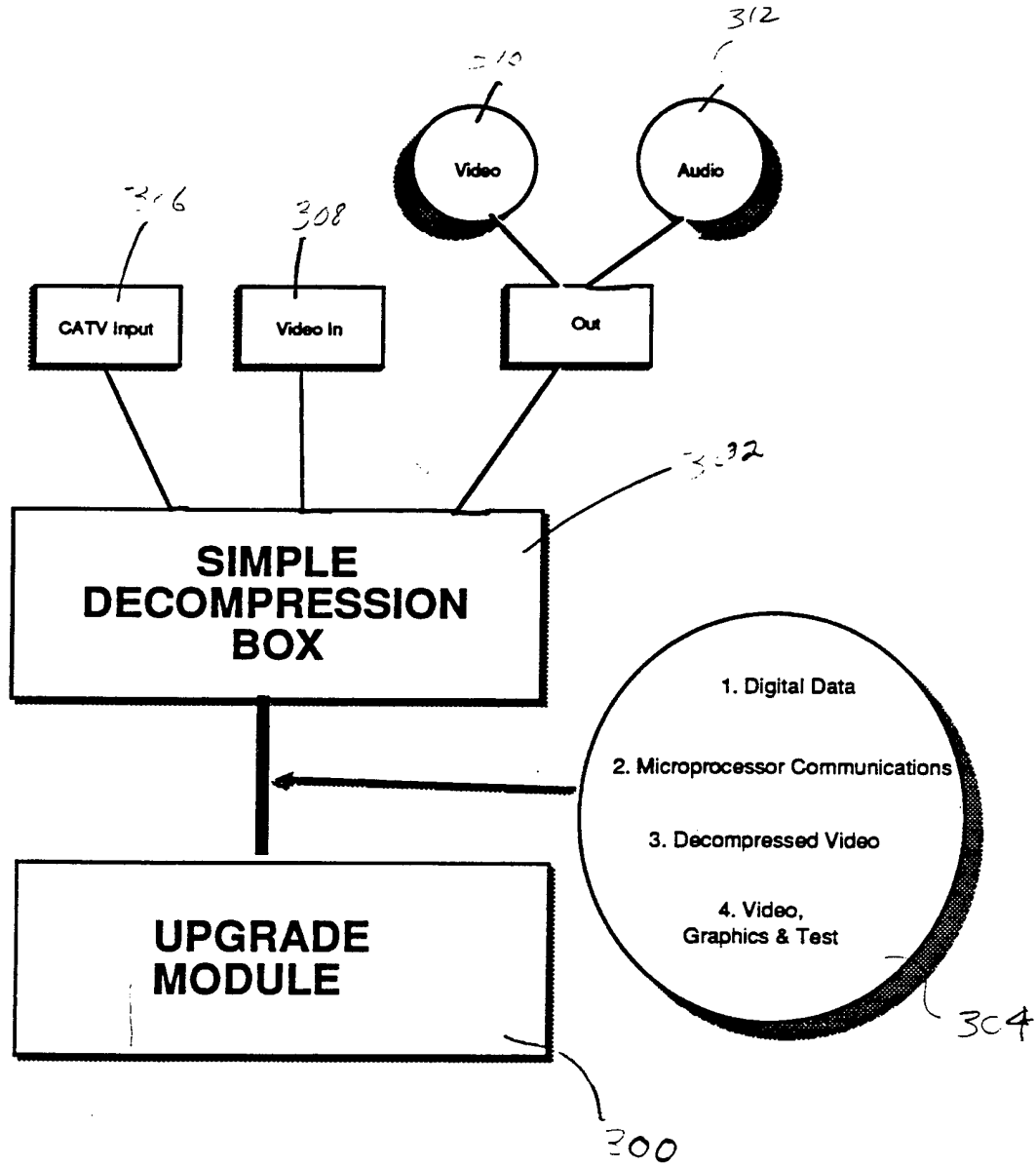

FIG. 9a

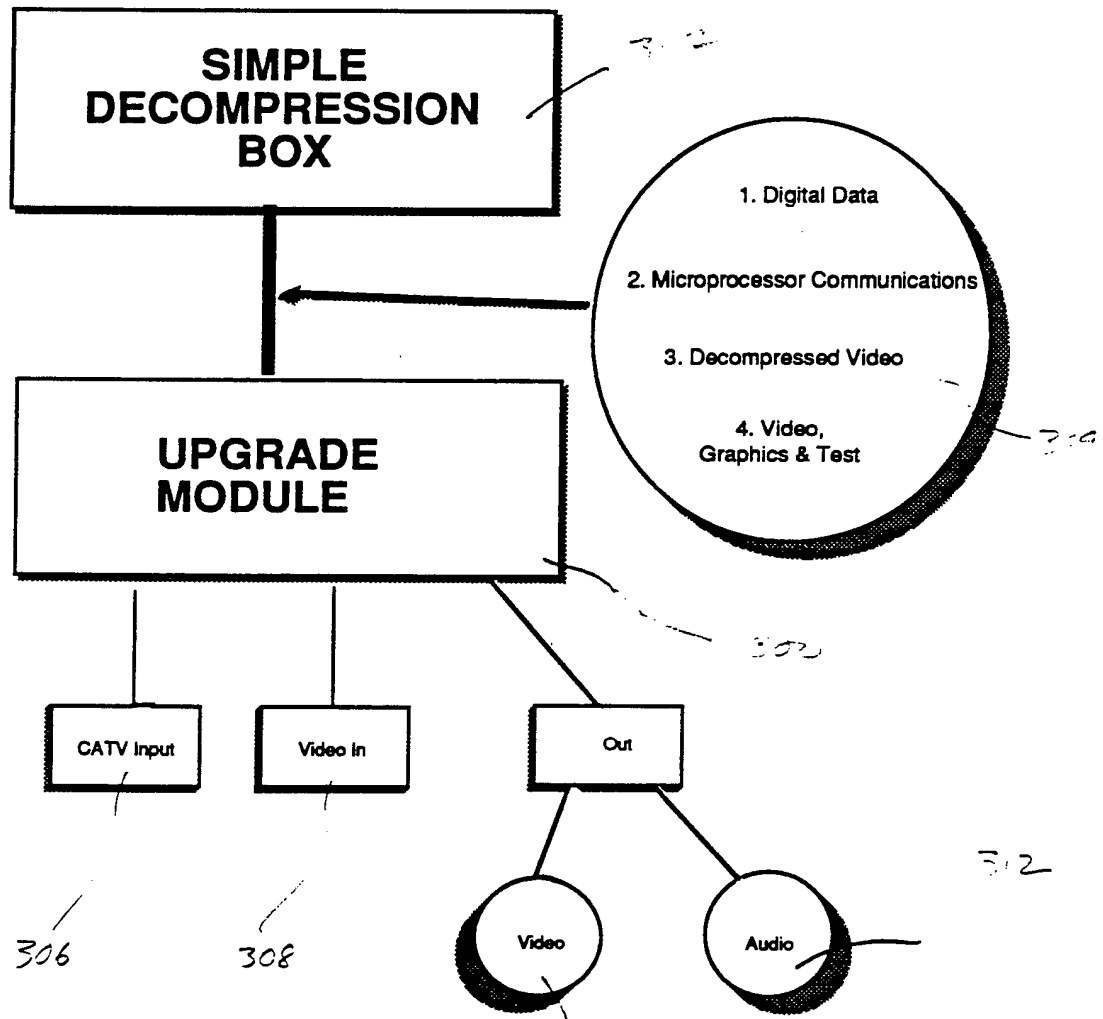

FIG. 9b



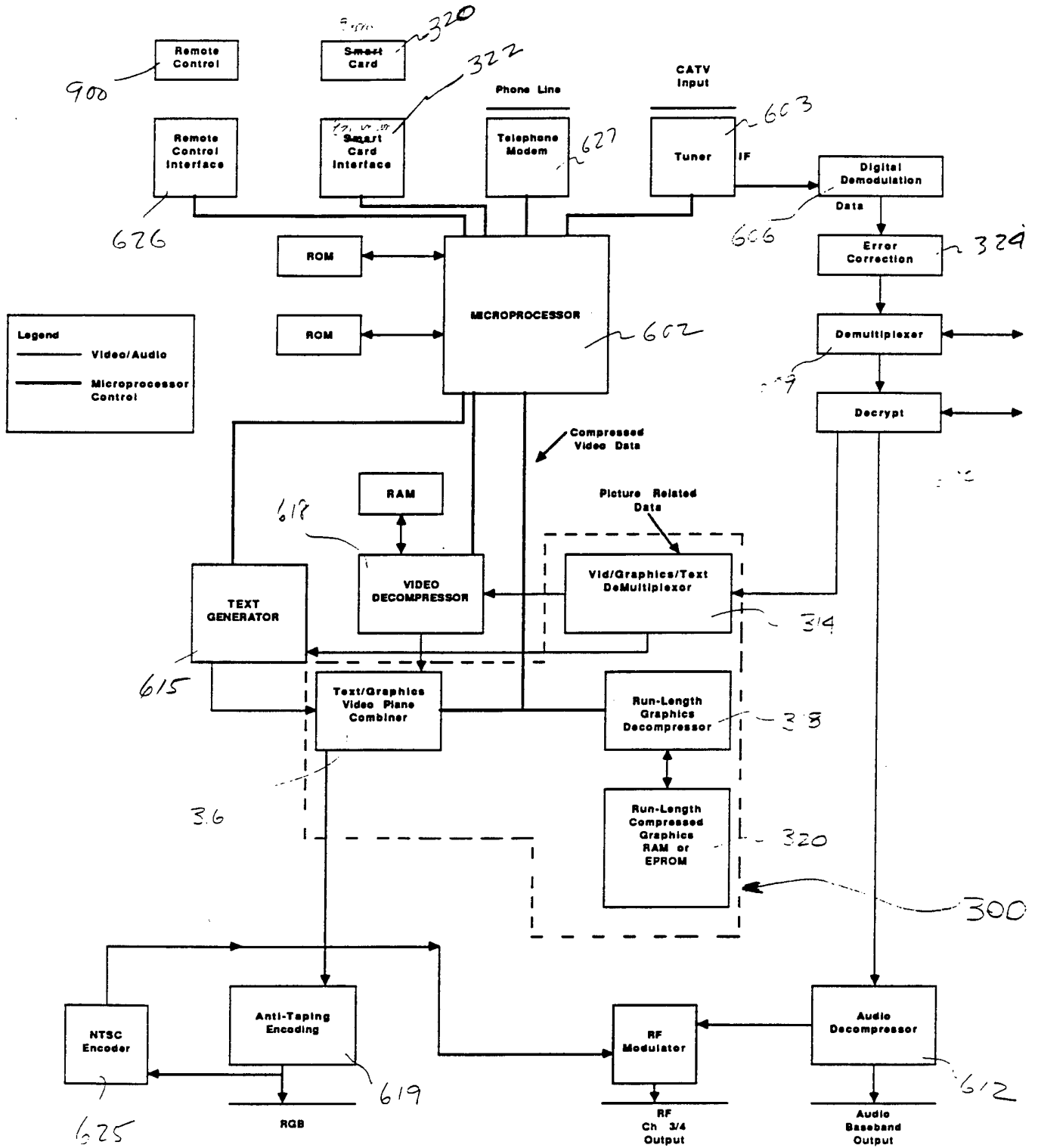
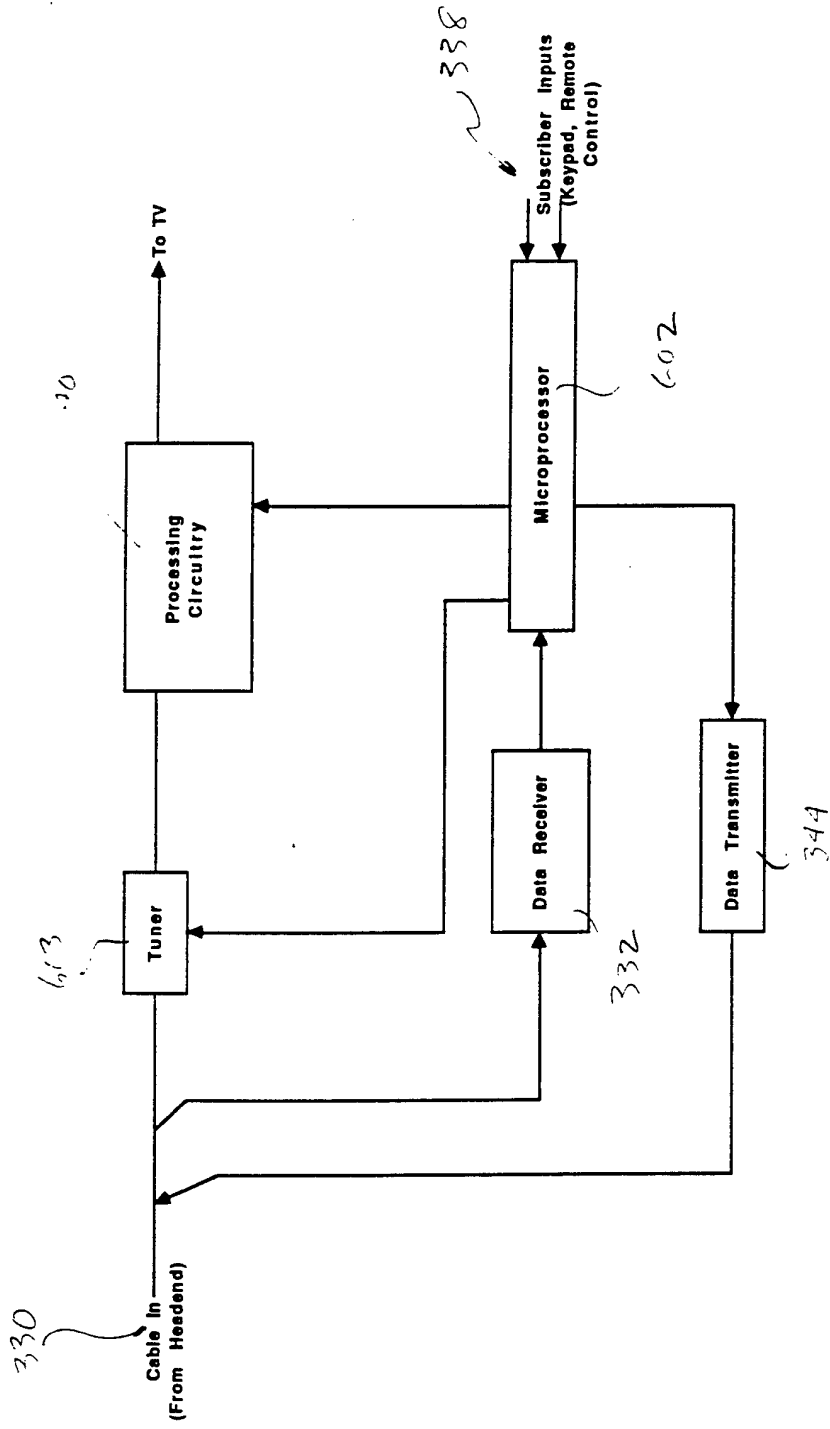

FIG. 10



Set Top Terminal Upstream Data Transmission Hardware

FIG. 11

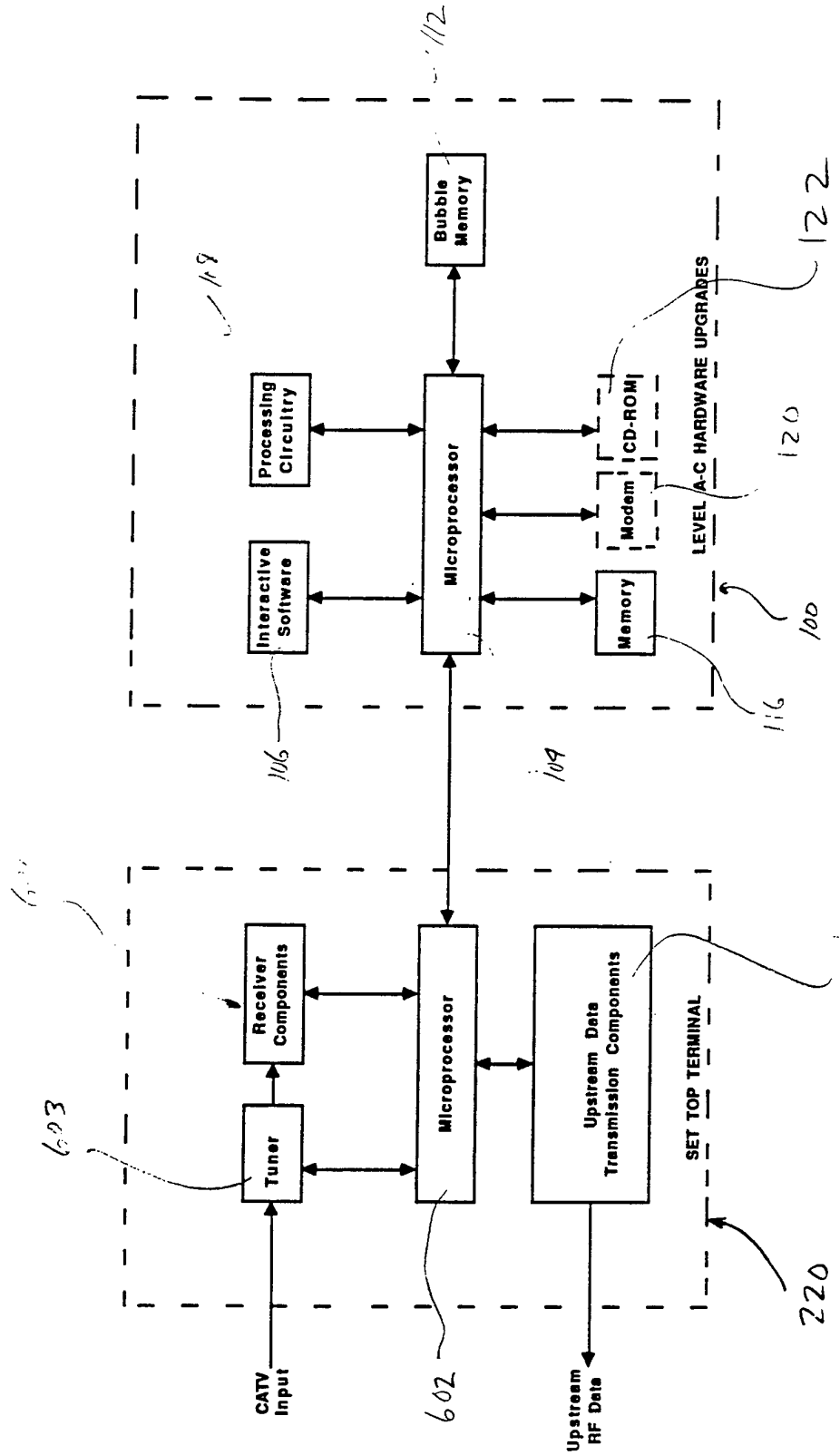

FIG. 12a

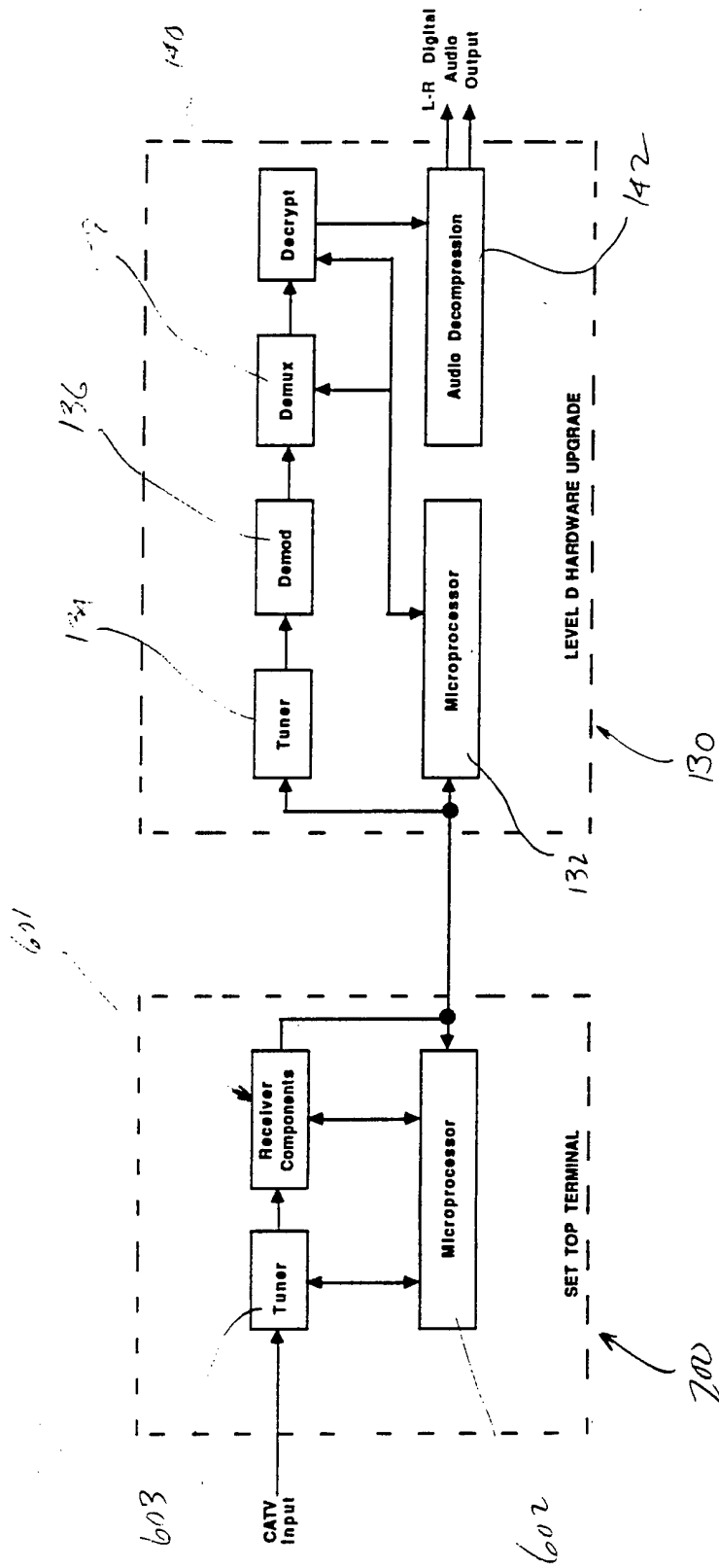

FIG. 12b

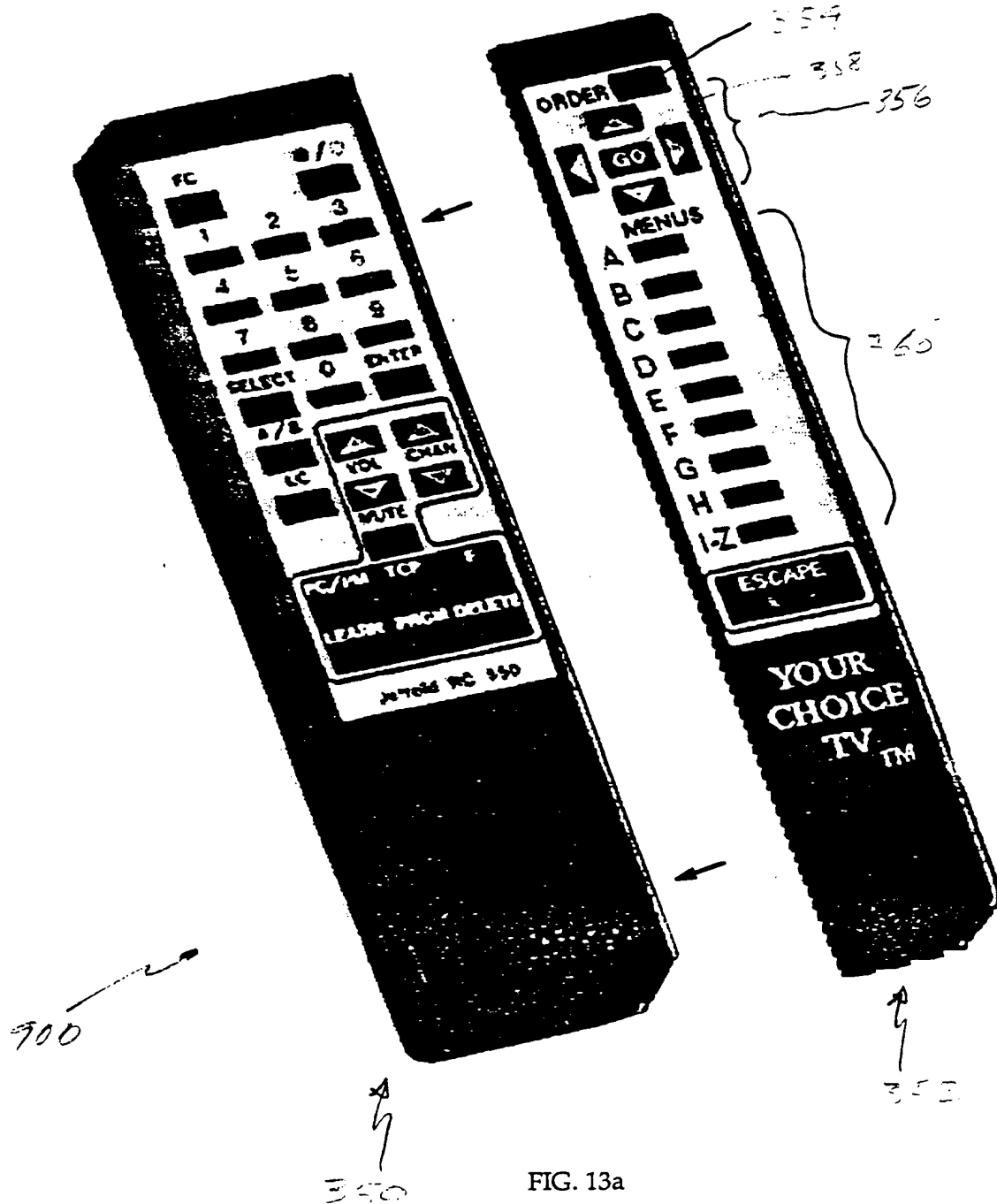

FIG. 13a



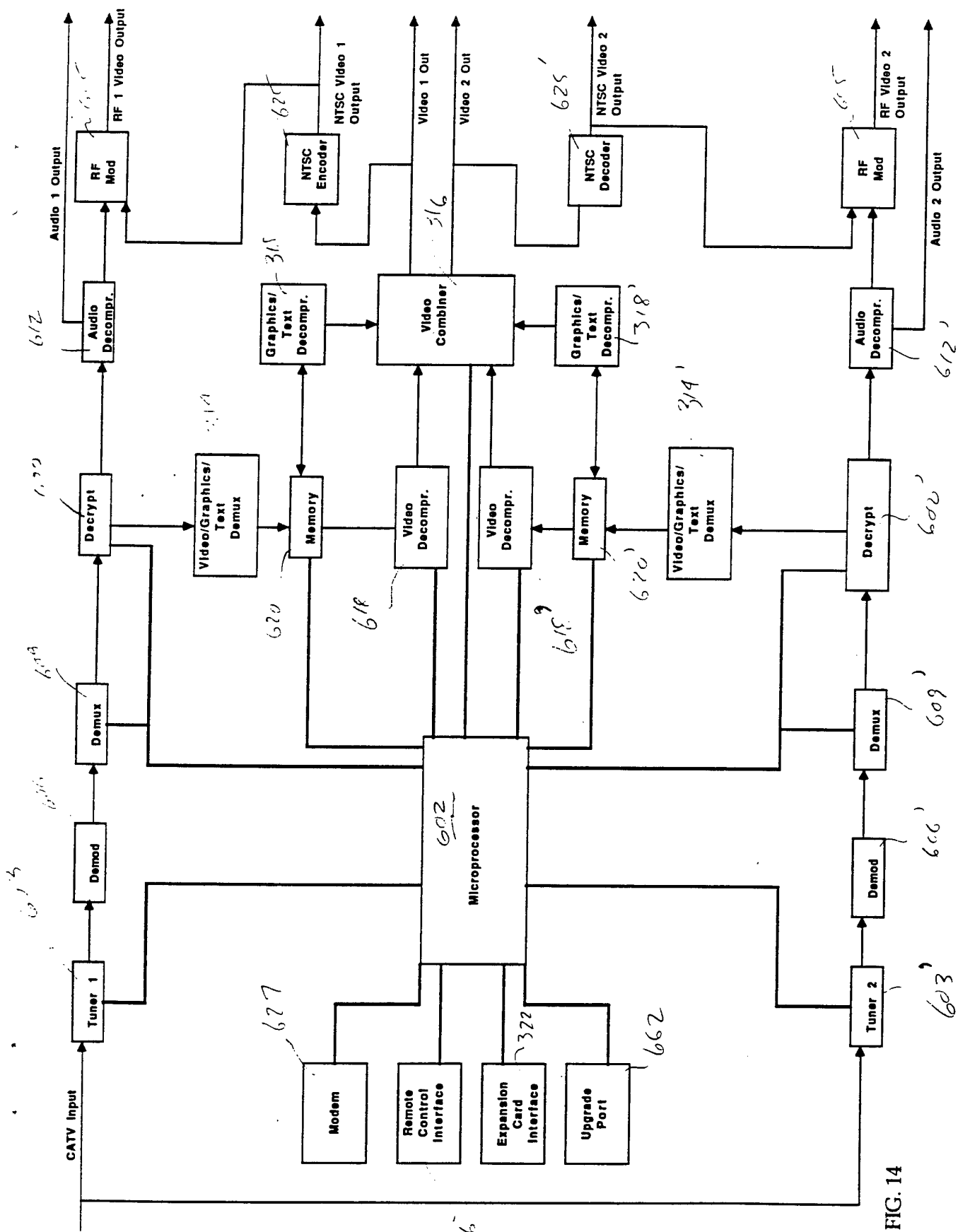

FIG. 14

FIG. 15

Thursday, October 26, 1994 7:57 PM

**TV GUIDE X\*PRESS**  
a TV Guide Liberty service

Press **GO** Or: Any Item for Show Schedules

**NETWORK SCHEDULES** next 7 days

**TODAY'S SCHEDULES** next 6 hours

**TV GUIDE PICKS** all networks next 7 days

Note: Press **GUIDE RECORD** button on any show listed and we will automatically set your VCR to tape it.

**YOUR CHOICE TV** You haven't subscribed to TV Guide X\*Press yet. Press **GO** Here to ORDER for just \$2.95/month. Press **EXIT** Here to Return to Cable TV.

72

9  
1130



FIG. 16a

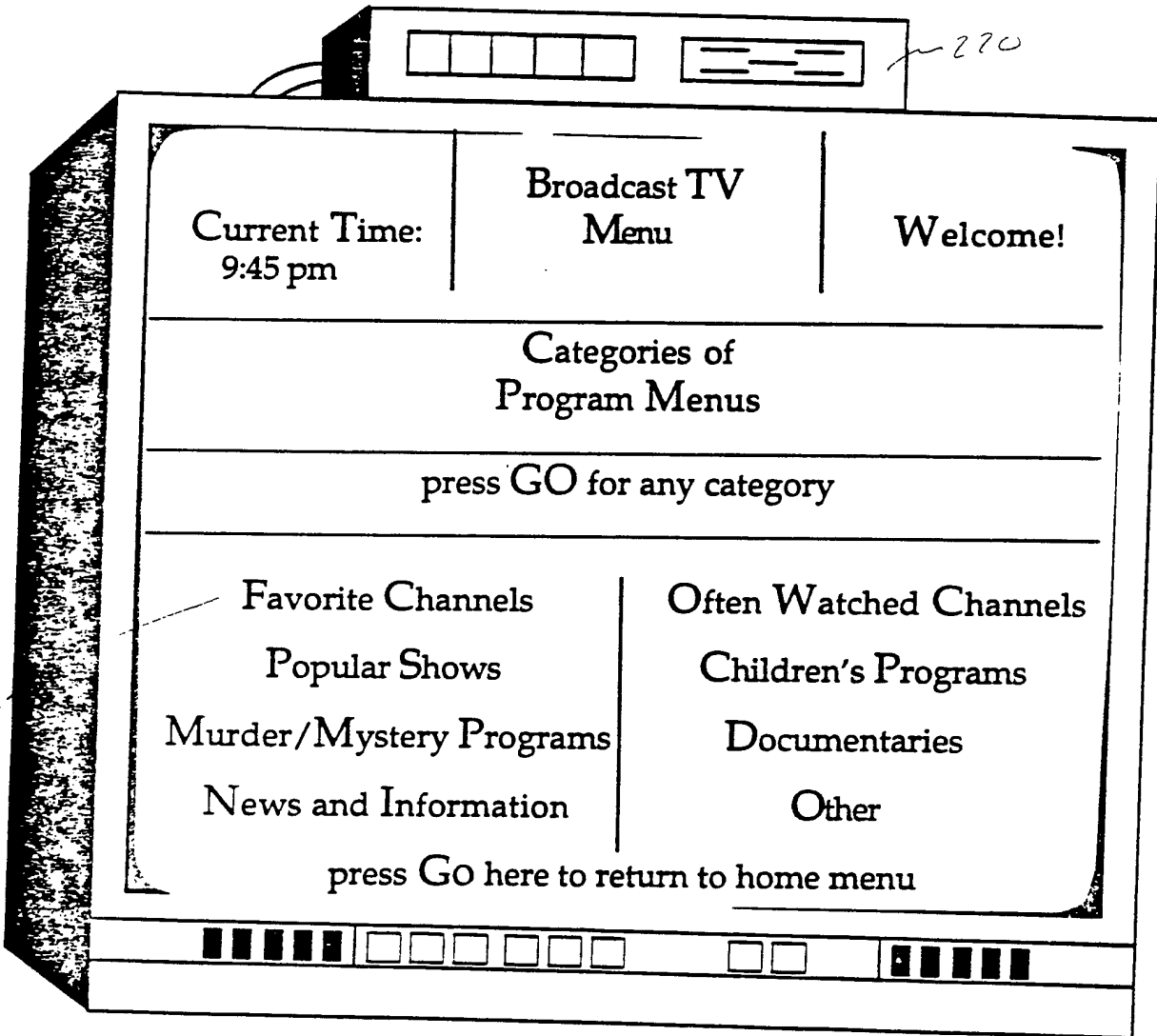

↑  
1112

### MOOD QUESTION MENUS

114 ↗

LENGTH OF PROGRAM DESIRED

Short	30 minutes or less
Medium	30 to 60 minutes
Long	60 minutes or more

FIG. 16b

116 ↗

Type of Program Desired

Serious
Thoughtful
Light

FIG. 16c

118 ↗

Do you wish an active or passive program?

Active
Passive

FIG. 16d

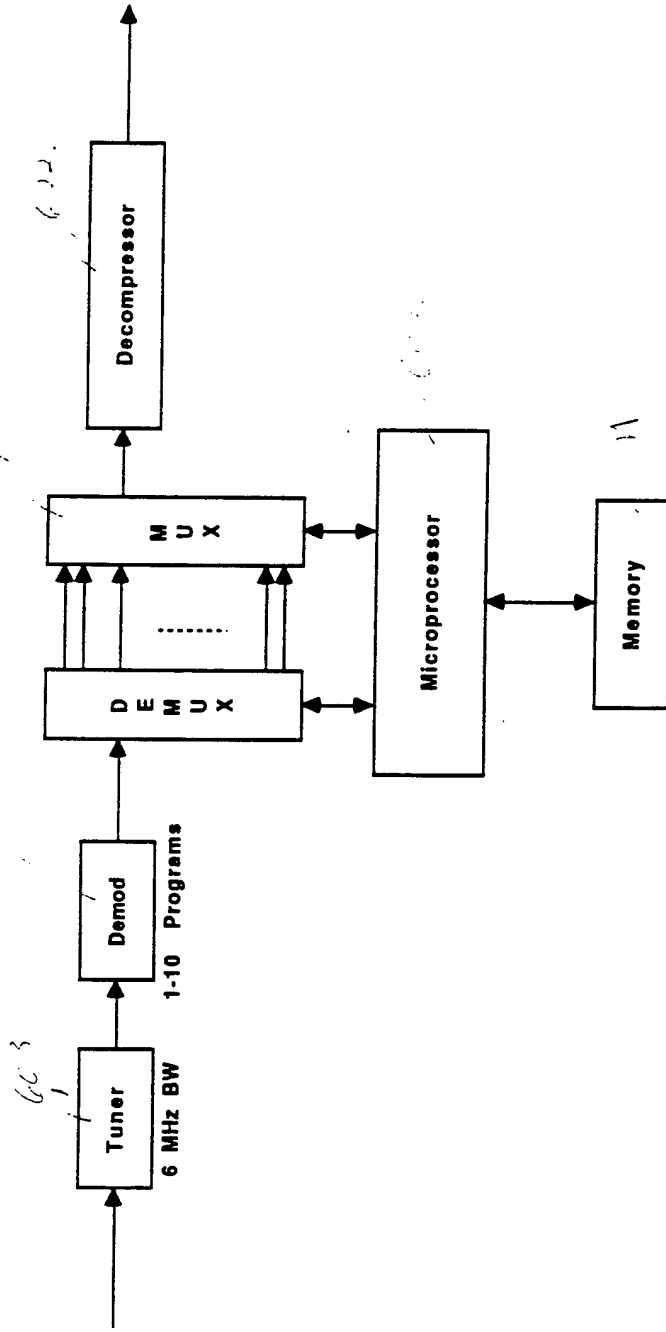
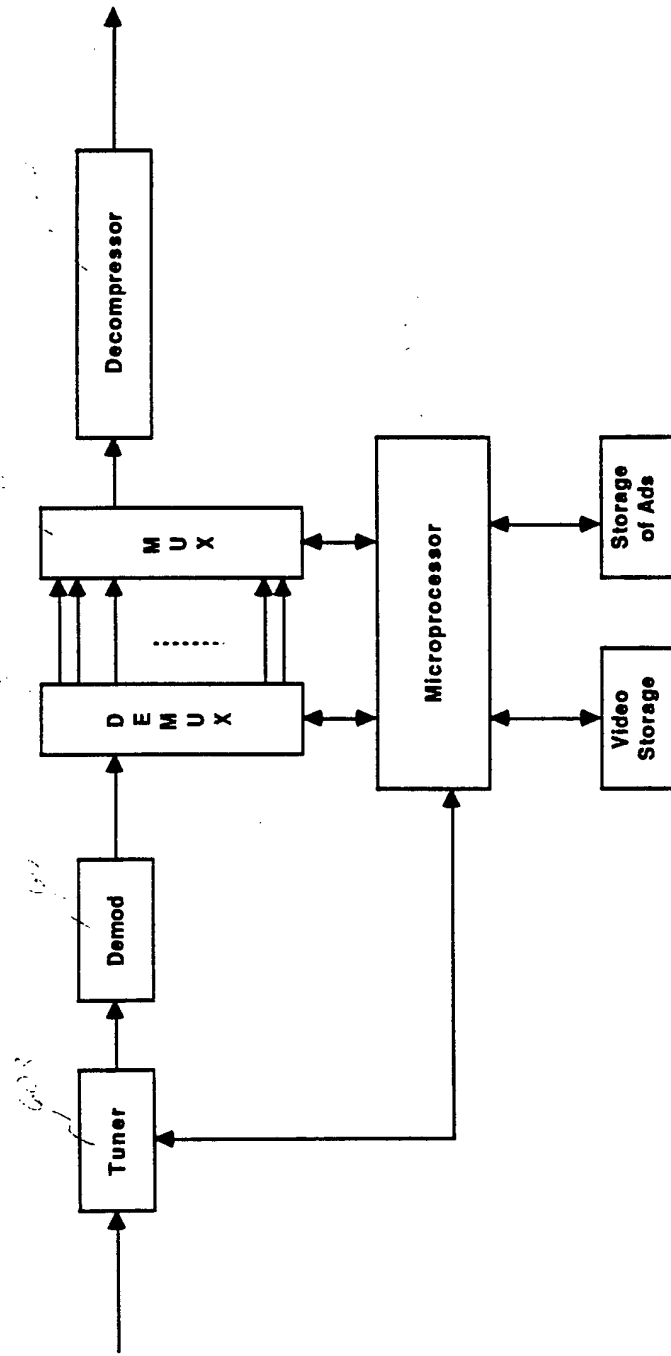

FIG. 17a STT CHANNEL SWITCHING HARDWARE: CHANNEL SWITCHING WITHIN 6MHz BANDWIDTH



STT CHANNEL SWITCHING HARDWARE: CHANNEL SWITCHING OUTSIDE 6MHz BANDWIDTH

FIG. 17b

FIG. 18

Thursday, October 26, 1994 8:00 PM

 **INTERACTIVE SERVICES  
LEVEL B**

This level of interactivity allows you to access a wide range of services including:

PROOF	ENCYCLOPEDIA
AMERICA ON LINE	ATLAS
STRESS	SHOPPING CENTER
AIRLINE RESERVATIONS	ASSOCIATED PRESS
MOBILE RESERVATIONS	U.S. YELLOW PAGES

To take advantage of these services, an INTERACTIVE MODEM is required. This is available from your cable system. For installation and price information, contact your cable system today.

**YOUR CABLE TV**

Press **5** Here for More Information  
Press **2** Here to Return to Cable TV

1120

FIG. 19a

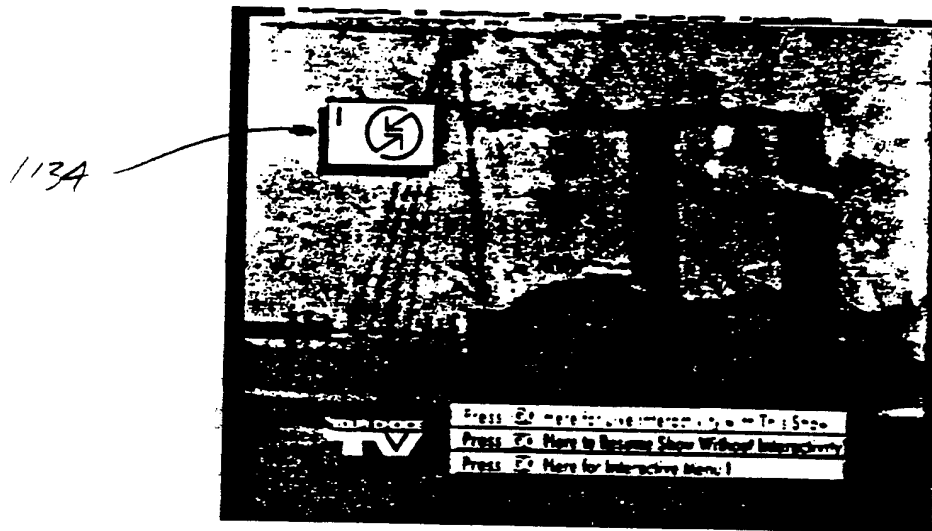

↑  
1130

FIG. 19b

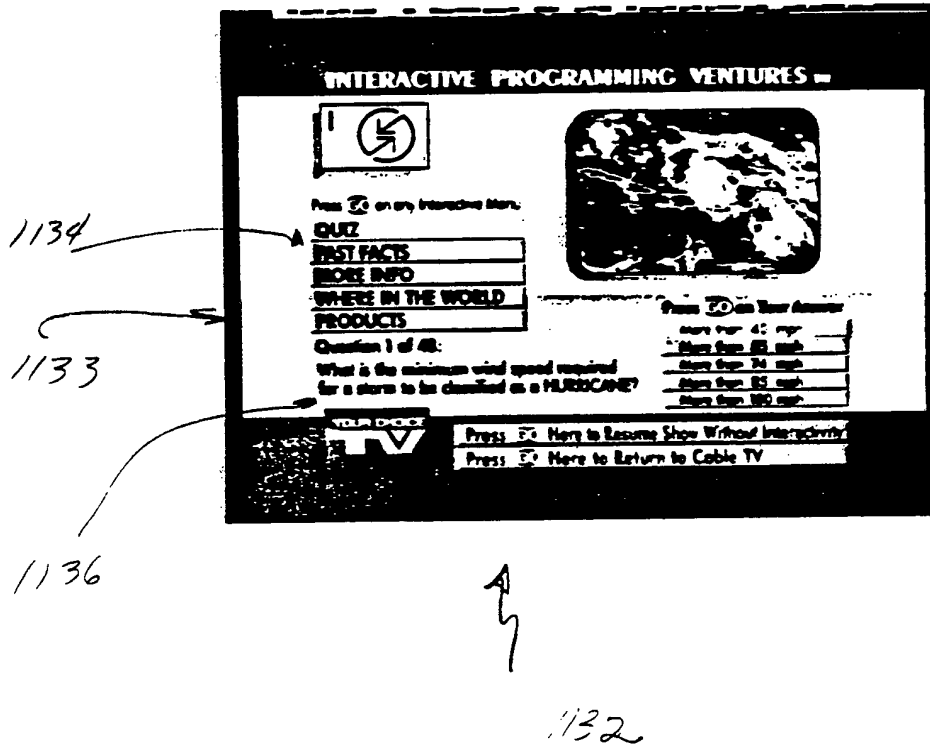

26 / 3 2

FIG. 20a

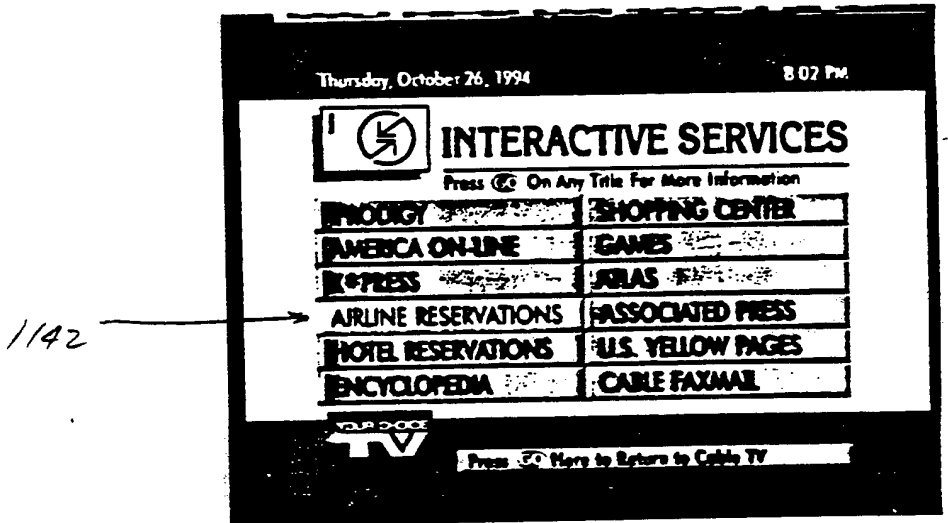



27 / 3 2

FIG. 20b

Thursday, October 26, 1994 8:04 PM



### AIRLINE INFORMATION AND RESERVATIONS(continued)

Here are your airline flight options for a morning departure from Phoenix to Dulles.  
Press **GO** on Any Flight to Check Availability and Fare

7:15AM	3:00PM	AMERICAN	49	0
7:30AM	3:15PM	AMERICAN	49	0
8:00AM	3:07PM	DELTA	49	0
8:30AM	3:37PM	DELTA	49	0
8:55AM	3:10PM	UNITED	49	0
9:15AM	3:30PM	UNITED	47	0

**GO TV** Press **GO** Here to Return to Flight Main Menu  
Press **GO** Here to Return to Menu  
Press **GO** Here to Return to Cable TV

9  
1144

FIG. 20c

Thursday, October 26, 1994 8:05 PM

 **AIRLINE INFORMATION AND RESERVATIONS**(continued)

DELTA FLIGHT #49 from Phoenix to Dulles direct  
 departs 8:00AM and arrives 3:07PM

SEATS AVAILABLE ARE SHOWN IN BLUE

3 First Class Seats Remaining  
 15 Coach Class Seats Remaining

Press **GO** on Any Blue Seat(s) to Make Reservations

First Class	Coach Class	Aircraft Equipment 757																																																																																																																																																																																																																																																																																																												
<table border="1"> <tr><td>1</td><td>2</td><td>3</td><td>4</td><td>5</td><td>6</td><td>7</td><td>8</td><td>9</td><td>10</td><td>11</td><td>12</td><td>13</td><td>14</td><td>15</td><td>16</td><td>17</td><td>18</td><td>19</td><td>20</td><td>21</td><td>22</td><td>23</td><td>24</td><td>25</td><td>26</td><td>27</td><td>28</td><td>29</td><td>30</td><td>31</td><td>32</td><td>33</td><td>34</td><td>35</td><td>36</td><td>37</td><td>38</td><td>39</td><td>40</td><td>41</td><td>42</td><td>43</td><td>44</td><td>45</td><td>46</td><td>47</td><td>48</td><td>49</td><td>50</td><td>51</td><td>52</td><td>53</td><td>54</td><td>55</td><td>56</td><td>57</td><td>58</td><td>59</td><td>60</td><td>61</td><td>62</td><td>63</td><td>64</td><td>65</td><td>66</td><td>67</td><td>68</td><td>69</td><td>70</td><td>71</td><td>72</td><td>73</td><td>74</td><td>75</td><td>76</td><td>77</td><td>78</td><td>79</td><td>80</td><td>81</td><td>82</td><td>83</td><td>84</td><td>85</td><td>86</td><td>87</td><td>88</td><td>89</td><td>90</td><td>91</td><td>92</td><td>93</td><td>94</td><td>95</td><td>96</td><td>97</td><td>98</td><td>99</td><td>100</td></tr> </table>	1	2	3	4	5	6	7	8	9	10	11	12	13	14	15	16	17	18	19	20	21	22	23	24	25	26	27	28	29	30	31	32	33	34	35	36	37	38	39	40	41	42	43	44	45	46	47	48	49	50	51	52	53	54	55	56	57	58	59	60	61	62	63	64	65	66	67	68	69	70	71	72	73	74	75	76	77	78	79	80	81	82	83	84	85	86	87	88	89	90	91	92	93	94	95	96	97	98	99	100	<table border="1"> <tr><td>1</td><td>2</td><td>3</td><td>4</td><td>5</td><td>6</td><td>7</td><td>8</td><td>9</td><td>10</td><td>11</td><td>12</td><td>13</td><td>14</td><td>15</td><td>16</td><td>17</td><td>18</td><td>19</td><td>20</td><td>21</td><td>22</td><td>23</td><td>24</td><td>25</td><td>26</td><td>27</td><td>28</td><td>29</td><td>30</td><td>31</td><td>32</td><td>33</td><td>34</td><td>35</td><td>36</td><td>37</td><td>38</td><td>39</td><td>40</td><td>41</td><td>42</td><td>43</td><td>44</td><td>45</td><td>46</td><td>47</td><td>48</td><td>49</td><td>50</td><td>51</td><td>52</td><td>53</td><td>54</td><td>55</td><td>56</td><td>57</td><td>58</td><td>59</td><td>60</td><td>61</td><td>62</td><td>63</td><td>64</td><td>65</td><td>66</td><td>67</td><td>68</td><td>69</td><td>70</td><td>71</td><td>72</td><td>73</td><td>74</td><td>75</td><td>76</td><td>77</td><td>78</td><td>79</td><td>80</td><td>81</td><td>82</td><td>83</td><td>84</td><td>85</td><td>86</td><td>87</td><td>88</td><td>89</td><td>90</td><td>91</td><td>92</td><td>93</td><td>94</td><td>95</td><td>96</td><td>97</td><td>98</td><td>99</td><td>100</td></tr> </table>	1	2	3	4	5	6	7	8	9	10	11	12	13	14	15	16	17	18	19	20	21	22	23	24	25	26	27	28	29	30	31	32	33	34	35	36	37	38	39	40	41	42	43	44	45	46	47	48	49	50	51	52	53	54	55	56	57	58	59	60	61	62	63	64	65	66	67	68	69	70	71	72	73	74	75	76	77	78	79	80	81	82	83	84	85	86	87	88	89	90	91	92	93	94	95	96	97	98	99	100	<table border="1"> <tr><td>1</td><td>2</td><td>3</td><td>4</td><td>5</td><td>6</td><td>7</td><td>8</td><td>9</td><td>10</td><td>11</td><td>12</td><td>13</td><td>14</td><td>15</td><td>16</td><td>17</td><td>18</td><td>19</td><td>20</td><td>21</td><td>22</td><td>23</td><td>24</td><td>25</td><td>26</td><td>27</td><td>28</td><td>29</td><td>30</td><td>31</td><td>32</td><td>33</td><td>34</td><td>35</td><td>36</td><td>37</td><td>38</td><td>39</td><td>40</td><td>41</td><td>42</td><td>43</td><td>44</td><td>45</td><td>46</td><td>47</td><td>48</td><td>49</td><td>50</td><td>51</td><td>52</td><td>53</td><td>54</td><td>55</td><td>56</td><td>57</td><td>58</td><td>59</td><td>60</td><td>61</td><td>62</td><td>63</td><td>64</td><td>65</td><td>66</td><td>67</td><td>68</td><td>69</td><td>70</td><td>71</td><td>72</td><td>73</td><td>74</td><td>75</td><td>76</td><td>77</td><td>78</td><td>79</td><td>80</td><td>81</td><td>82</td><td>83</td><td>84</td><td>85</td><td>86</td><td>87</td><td>88</td><td>89</td><td>90</td><td>91</td><td>92</td><td>93</td><td>94</td><td>95</td><td>96</td><td>97</td><td>98</td><td>99</td><td>100</td></tr> </table>	1	2	3	4	5	6	7	8	9	10	11	12	13	14	15	16	17	18	19	20	21	22	23	24	25	26	27	28	29	30	31	32	33	34	35	36	37	38	39	40	41	42	43	44	45	46	47	48	49	50	51	52	53	54	55	56	57	58	59	60	61	62	63	64	65	66	67	68	69	70	71	72	73	74	75	76	77	78	79	80	81	82	83	84	85	86	87	88	89	90	91	92	93	94	95	96	97	98	99	100
1	2	3	4	5	6	7	8	9	10	11	12	13	14	15	16	17	18	19	20	21	22	23	24	25	26	27	28	29	30	31	32	33	34	35	36	37	38	39	40	41	42	43	44	45	46	47	48	49	50	51	52	53	54	55	56	57	58	59	60	61	62	63	64	65	66	67	68	69	70	71	72	73	74	75	76	77	78	79	80	81	82	83	84	85	86	87	88	89	90	91	92	93	94	95	96	97	98	99	100																																																																																																																																																																																																											
1	2	3	4	5	6	7	8	9	10	11	12	13	14	15	16	17	18	19	20	21	22	23	24	25	26	27	28	29	30	31	32	33	34	35	36	37	38	39	40	41	42	43	44	45	46	47	48	49	50	51	52	53	54	55	56	57	58	59	60	61	62	63	64	65	66	67	68	69	70	71	72	73	74	75	76	77	78	79	80	81	82	83	84	85	86	87	88	89	90	91	92	93	94	95	96	97	98	99	100																																																																																																																																																																																																											
1	2	3	4	5	6	7	8	9	10	11	12	13	14	15	16	17	18	19	20	21	22	23	24	25	26	27	28	29	30	31	32	33	34	35	36	37	38	39	40	41	42	43	44	45	46	47	48	49	50	51	52	53	54	55	56	57	58	59	60	61	62	63	64	65	66	67	68	69	70	71	72	73	74	75	76	77	78	79	80	81	82	83	84	85	86	87	88	89	90	91	92	93	94	95	96	97	98	99	100																																																																																																																																																																																																											

**GO** Press to Enter Flight and Board  
**GO** Press to Cancel Above and Exit  
**GO** Press to Confirm

**GO** TV

1152



1150



FIG. 21

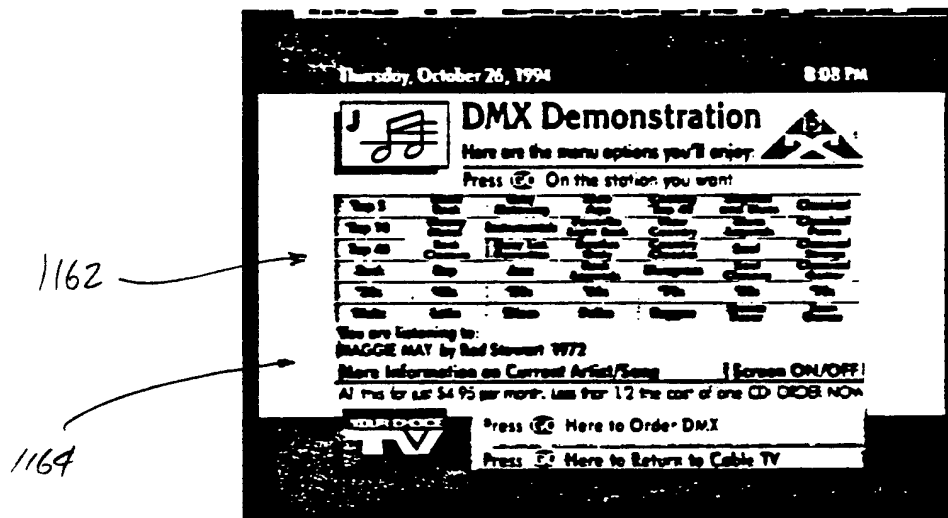
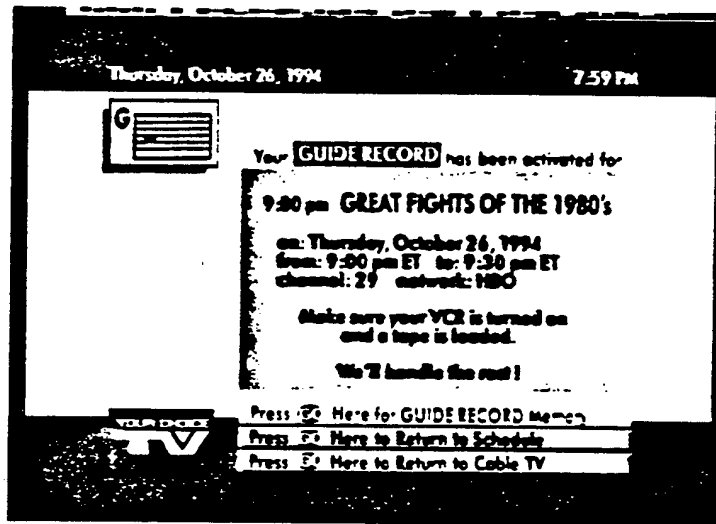
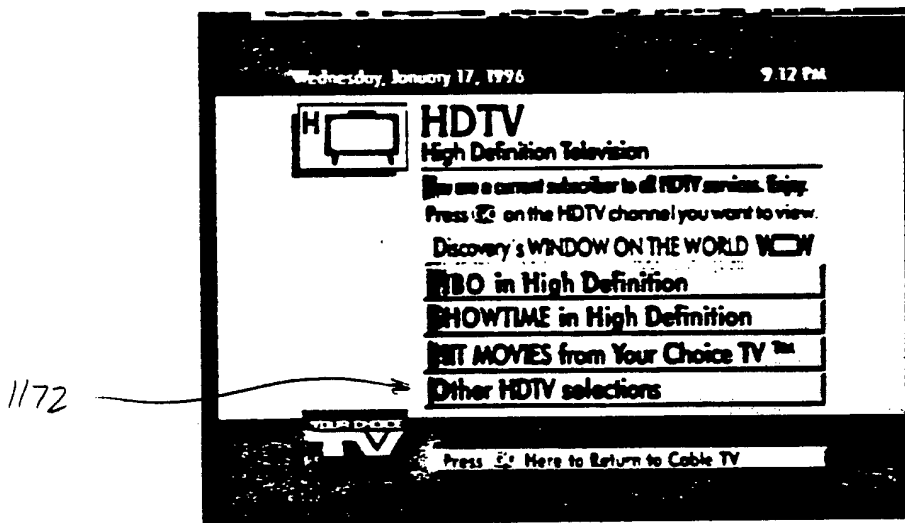

FIG. 22



1170

FIG. 23



1032

INTERNATIONAL SEARCH REPORT

International Application No  
PCT/US 93/11606

A. CLASSIFICATION OF SUBJECT MATTER  
IPC 5 H04N7/16 H04N7/173

According to International Patent Classification (IPC) or to both national classification and IPC

B. FIELDS SEARCHED

Minimum documentation searched (classification system followed by classification symbols)  
IPC 5 H04N

Documentation searched other than minimum documentation to the extent that such documents are included in the fields searched

Electronic data base consulted during the international search (name of data base and, where practical, search terms used)

C. DOCUMENTS CONSIDERED TO BE RELEVANT

Category *	Citation of document, with indication, where appropriate, of the relevant passages	Relevant to claim No.
Y	EP,A,0 506 435 (SCIENTIFIC ATLANTA) 30 September 1992	1, 10, 15, 17, 19, 25, 40-42
A	see page 14, line 53 - page 16, line 49	2-9, 11-14, 16, 18, 20-24, 26-39, 43
	---	-/--

Further documents are listed in the continuation of box C.

Patent family members are listed in annex.

\* Special categories of cited documents :

- \*A\* document defining the general state of the art which is not considered to be of particular relevance
- \*E\* earlier document but published on or after the international filing date
- \*L\* document which may throw doubts on priority claim(s) or which is cited to establish the publication date of another citation or other special reason (as specified)
- \*O\* document referring to an oral disclosure, use, exhibition or other means
- \*P\* document published prior to the international filing date but later than the priority date claimed

- \*T\* later document published after the international filing date or priority date and not in conflict with the application but cited to understand the principle or theory underlying the invention
- \*X\* document of particular relevance; the claimed invention cannot be considered novel or cannot be considered to involve an inventive step when the document is taken alone
- \*Y\* document of particular relevance; the claimed invention cannot be considered to involve an inventive step when the document is combined with one or more other such documents, such combination being obvious to a person skilled in the art.
- \*&\* document member of the same patent family

Date of the actual completion of the international search

8 March 1994

Date of mailing of the international search report

30. 03. 94

Name and mailing address of the ISA

European Patent Office, P.B. 5818 Patentlaan 2  
NL - 2280 HV Rijswijk  
Tel. (+ 31-70) 340-2040, Tx. 31 651 epo nl,  
Fax: (+ 31-70) 340-3016

Authorized officer

Greve, M

## INTERNATIONAL SEARCH REPORT

Int. Patent Application No

PCT/US 93/11606

## C.(Continuation) DOCUMENTS CONSIDERED TO BE RELEVANT

Category *	Citation of document, with indication, where appropriate, of the relevant passages	Relevant to claim No.
Y	JOURNAL OF LIGHTWAVE TECHNOLOGY vol. 10, no. 11 , November 1992 , NEW YORK, US pages 1760 - 1765 XP000355287 R.OLSHANSKY ET AL. 'SUBSCRIBER DISTRIBUTION NETWORKS USING COMPRESSED DIGITAL VIDEO'	1, 10, 15, 25, 40-42
A	see the whole document	2-9, 11-14, 16-24, 26-39, 43
Y	--- US,A,5 144 663 (KUDELSKI ET AL.) 1 September 1992	17, 19
A	see the whole document	1-16, 18, 20-43
A	--- WO,A,86 01962 (SCIENTIFIC ATLANTA) 27 March 1986 see the whole document	1-43
Y	--- EP,A,0 355 697 (HITACHI) 28 February 1990	34, 39, 43
A	see page 6, line 19 - page 18, line 23	35-38, 40-42
Y	--- EP,A,0 402 809 (MAGUS) 19 December 1990	34, 39, 43
A	see page 2, line 5 - page 5, line 5	35-38, 40-42
	-----	



## INTERNATIONAL SEARCH REPORT

information on patent family members

International Application No

PCT/US 93/11606

Patent document cited in search report	Publication date	Patent family member(s)	Publication date
EP-A-0506435	30-09-92	US-A- 5237610	17-08-93
		AU-A- 1384092	01-10-92
		CN-A- 1066950	09-12-92
		JP-A- 5145923	11-06-93
US-A-5144663	01-09-92	AU-B- 599646	26-07-90
		AU-A- 7157887	22-10-87
		EP-A- 0243312	28-10-87
		JP-A- 63023488	30-01-88
WO-A-8601962	27-03-86	US-A- 4885775	05-12-89
		AU-B- 586832	27-07-89
		AU-A- 4800785	08-04-86
		CA-A- 1266525	06-03-90
		EP-A, B 0194289	17-09-86
		JP-T- 62500486	26-02-87
		US-A- 4890319	26-12-89
		US-A- 4829569	09-05-89
EP-A-0355697	28-02-90	JP-A- 2054646	23-02-90
		US-A- 5027400	25-06-91
EP-A-0402809	19-12-90	US-A- 5101267	31-03-92
		AU-B- 634242	18-02-93
		AU-A- 5693790	20-12-90
		CA-A- 2018539	13-12-90
		CN-A- 1048136	26-12-90
		JP-A- 3064286	19-03-91
		US-A- 5257099	26-10-93
		US-A- 5223923	29-06-93



INTERNATIONAL APPLICATION PUBLISHED UNDER THE PATENT COOPERATION TREATY (PCT)

<p>(51) International Patent Classification <sup>5</sup> : H04N 7/16, 7/173</p>	<p>A1</p>	<p>(11) International Publication Number: <b>WO 94/13107</b> (43) International Publication Date: 9 June 1994 (09.06.94)</p>
<p>(21) International Application Number: PCT/US93/11606 (22) International Filing Date: 2 December 1993 (02.12.93) (30) Priority Data: 07/991,074 2 December 1992 (02.12.92) US (71) Applicant: DISCOVERY COMMUNICATIONS, INC. [US/US]; 7700 Wisconsin Avenue, Bethesda, MD 20814-3522 (US). (72) Inventors: HENDRICKS, John, S.; 8723 Persimmon Tree Road, Potomac, MD 20854 (US). BONNER, Alfred, E.; 8300 Bradley Boulevard, Bethesda, MD 20817 (US). WUNDERLICH, Richard, E.; 290 Sweet Briar Court, Alpharetta, GA 30201 (US). BERKOBIN, Eric, C.; 108 Hillview Court, Woodstock, GA 30188 (US). (74) Agents: NOTO, Aldo; Dorsey &amp; Whitney, 1330 Connecticut Avenue, N.W., Suite 200, Washington, DC 20036 (US) et al.</p>	<p>(81) Designated States: AT, AU, BB, BG, BR, BY, CA, CH, CZ, DE, DK, ES, FI, GB, HU, JP, KP, KR, KZ, LK, LU, LV, MG, MN, MW, NL, NO, NZ, PL, PT, RO, RU, SD, SE, SK, UA, VN, European patent (AT, BE, CH, DE, DK, ES, FR, GB, GR, IE, IT, LU, MC, NL, PT, SE), OAPI patent (BF, BJ, CF, CG, CI, CM, GA, GN, ML, MR, NE, SN, TD, TG).</p> <p>Published With international search report. With amended claims and statement.</p> <p>Date of publication of the amended claims and statement: 21 July 1994 (21.07.94)</p>	

(54) Title: ADVANCED SET TOP TERMINAL FOR CABLE TELEVISION DELIVERY SYSTEMS

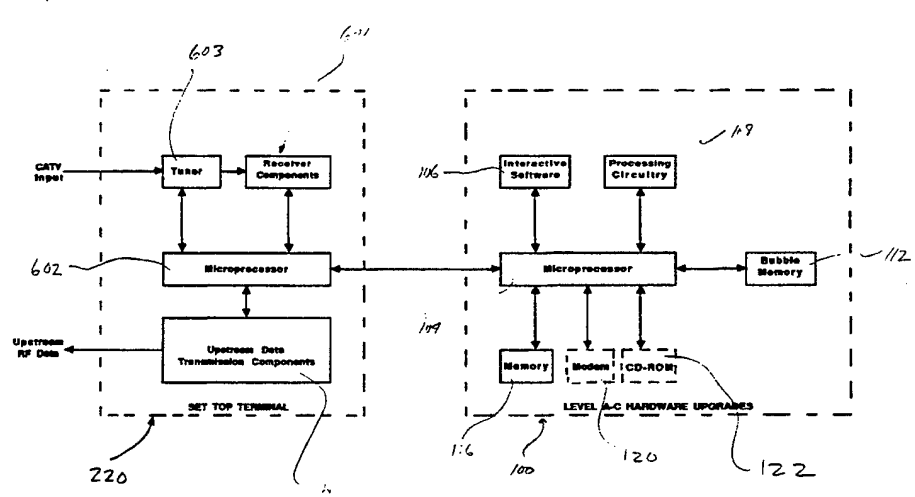

**(57) Abstract**

A novel advanced set top terminal capable of digital decompression, menu generation, interactivity and other advanced functional capabilities for use in a television program delivery system (200) is described. The invention relates to methods and apparatus for upgrading existing set top terminals (220) to provide menu generation capability and advanced functional capabilities. The invention is particularly useful in television program delivery systems (200) with hundreds of channels of programming, providing (i) menu driven program selection through the addition of an upgrade module (300) or menu generation card and (ii) advanced functional capabilities using a set of hardware upgrades (e.g. 130) and/or an expansion card. Specifically, the invention is an upgradeable system that supports advanced set top functionality through the use of internal software, hardware upgrades, an upgrade module and/or expansion cards. The upgraded hardware generally includes a microprocessor, various input/output ports (e.g., 308), processing circuitry (e.g., 108) and memory (e.g., 116). The invention results in an upgraded set top terminal that supports: menu generation; picture-on-picture displays; program catalogue services; interactive services; telephone caller identification; digital audio reception; VCR control; HDTV reception; and backyard satellite system interoperability, among other features and capabilities.

**FOR THE PURPOSES OF INFORMATION ONLY**

Codes used to identify States party to the PCT on the front pages of pamphlets publishing international applications under the PCT.

AT	Austria	GB	United Kingdom	MR	Mauritania
AU	Australia	GE	Georgia	MW	Malawi
BB	Barbados	GN	Guinea	NE	Niger
BE	Belgium	GR	Greece	NL	Netherlands
BF	Burkina Faso	HU	Hungary	NO	Norway
BG	Bulgaria	IE	Ireland	NZ	New Zealand
BJ	Benin	IT	Italy	PL	Poland
BR	Brazil	JP	Japan	PT	Portugal
BY	Belarus	KE	Kenya	RO	Romania
CA	Canada	KG	Kyrgyzstan	RU	Russian Federation
CF	Central African Republic	KP	Democratic People's Republic of Korea	SD	Sudan
CG	Congo	KR	Republic of Korea	SE	Sweden
CH	Switzerland	KZ	Kazakhstan	SI	Slovenia
CI	Côte d'Ivoire	LI	Liechtenstein	SK	Slovakia
CM	Cameroon	LK	Sri Lanka	SN	Senegal
CN	China	LU	Luxembourg	TD	Chad
CS	Czechoslovakia	LV	Larvia	TG	Togo
CZ	Czech Republic	MC	Monaco	TJ	Tajikistan
DE	Germany	MD	Republic of Moldova	TT	Trinidad and Tobago
DK	Denmark	MG	Madagascar	UA	Ukraine
ES	Spain	ML	Mali	US	United States of America
FI	Finland	MN	Mongolia	UZ	Uzbekistan
FR	France			VN	Viet Nam
GA	Gabon				

## AMENDED CLAIMS

[received by the International Bureau on 30 May 1994 (30.05.94);  
original claims unchanged; new claims 44-46 added (3 pages)]

received from a remote location, the method comprising the steps of:

- 5           providing an electronic connection to the set top converter;
- demultiplexing the control information stream into graphics and text, whereby the control information stream is received from the set top converter;
- 10          graphically decompressing the graphics to produce decompressed graphics that may be used to generate menus; and
- connecting the menu generation card to the set top converter; and
- 15          using the menu generation card to combine the text and decompressed graphics to produce a menu generation signal, whereby the menu generation signal is output to the set top converter to be processed for display.

- 20   44. An upgrade module for enhancing the functionality of a decompression box for use in a cable television program delivery system, the enhanced functionality using a control information stream and providing the decompression box with menu generation capability, the decompression box initially having the capability to produce decompressed video, the upgrade module
- 25   comprising:

          an interface means for providing an electronic connection to the decompression box so that the control information stream may be received from the decompression box;

a means for demultiplexing the control information stream into graphics, text and menu generation information that includes information on program packaging and menu content;

5 a means for combining the graphics, text and menu generation information to produce a menu generation signal; and

a means for transferring the menu generation signal to the interface means for output to the decompression box, whereby the menu generation signal is processed for display.

10

45. A remote control unit for use with a set top terminal, the set top terminal capable of receiving a plurality of digitally compressed television signals and digital program control information that may be used in generating a plurality of menus corresponding to the digitally compressed signals, each menu corresponding to a group of related programs or a single program and having menu content data carried by the program control information signal, the remote control unit comprising:

15

a plurality of switches comprising:

menu select switches capable of selecting a desired menu from the plurality of menus, the menu select switches having icons representing the groups of related television programs; and

25

cursor movement switches capable of causing a cursor to move on one of the plurality of menus; and

means, coupled to the plurality of switches, for communicating with the set-top terminal, wherein selection of one of the plurality of switches effects the processing in the set top terminal of the menu content carried by the digital program control information signal.

46. A method for enhancing the functionality of a cable-ready television for use in a cable television program delivery system, the cable-ready television having an electronic interface that accommodates the enhanced functionality using a control information stream, the enhanced functionality providing the cable-ready television with menu generation capability, the method comprising the steps of:

receiving the control information stream from the cable-ready television through the electronic interface;

demultiplexing the control information stream into graphics, text and menu generation information that includes information on program packaging and menu content;

combining the graphics, text and menu generation information to produce a menu generation signal; and

transferring the menu generation signal to the cable-ready television through the electronic interface, whereby the menu generation signal is processed for display.

## STATEMENT UNDER ARTICLE 19

Claims 44, 45 and 46 have been added in light of the references cited in the International Search Report.

European Patent Application, Pub. No. 0 506 435, discloses a system for controlling and authorizing subscriber access to encrypted program signals using addressed data packets. The disclosed system uses a loop-back uplink that: (i) receives a combined signal of audio, video, system data packets and addressed data packets, and (ii) strips the data packets from the audio and video signals for use with other audio and video signals. The publication, however, does not teach or suggest the processing of menu generation information to produce a menu generation signal, as in Claims 44 and 46.

The article from the Journal of Lightwave Technology, entitled "Subscriber Distribution Networks Using Decompressed Digital Video," analyzes the performance of MPEG signaling in a passive optical network. The article explains that provisioning of services can be accomplished remotely by transmitting decryption keys to a subscriber once new service requests or program orders are received. The article, however, does not teach or suggest the processing of digital control information at a subscriber location or producing a menu generation signal from which menus may be displayed, as in Claims 44 and 46

The Kudelski Patent, U.S. Pat. No. 5,144,663, discloses a method of interactive communication between a subscriber and a decoder in a pay television system. The patent discloses a method of placing teletext information onto analog video

information. The patent, however, does not teach or suggest the processing of digital control information at a subscriber location or producing a menu generation signal from which menus can be displayed, as in Claims 44 and 46.

European Patent Application, Pub. No. 0 355 697, discloses a multimedia broadcast system in which preview programs are downloaded from a cable headend and accessed from a screen using a cursor controlled by a remote control. The system makes use of downlink control information that may include a terminal identification code and descrambler information. The publication, however, does not teach or suggest the processing of menu content data carried by a digital program control information signal or effecting such processing by selection of a switch on a remote control, as in Claim 45.

European Patent Application, Pub. No. 0 402 809, discloses a satellite television system for audience polling and processing of answers over a wide area network. The publication discloses a scheme of positioning a question and answers on a video to be displayed on a TV and using a remote control unit to place a cursor on the chosen answer. The publication, however, does not teach the processing of menu content data carried by a digital program control information signal or effecting such processing by selection of a switch on a remote control, as in Claim 45.





INTERNATIONAL APPLICATION PUBLISHED UNDER THE PATENT COOPERATION TREATY (PCT)

<p>(51) International Patent Classification <sup>5</sup> : <b>H04N 7/16, 7/173</b></p>	<p><b>A1</b></p>	<p>(11) International Publication Number: <b>WO 94/13107</b>  (43) International Publication Date: 9 June 1994 (09.06.94)</p>
<p>(21) International Application Number: PCT/US93/11606 (22) International Filing Date: 2 December 1993 (02.12.93)  (30) Priority Data: 07/991,074 9 December 1992 (09.12.92) US  (71) Applicant: DISCOVERY COMMUNICATIONS, INC. [US/US]; 7700 Wisconsin Avenue, Bethesda, MD 20814-3522 (US).  (72) Inventors: HENDRICKS, John, S.; 8723 Persimmon Tree Road, Potomac, MD 20854 (US). BONNER, Alfred, E.; 8300 Bradley Boulevard, Bethesda, MD 20817 (US). WUNDERLICH, Richard, E.; 290 Sweet Briar Court, Alpharetta, GA 30201 (US). BERKOBIN, Eric, C.; 108 Hillview Court, Woodstock, GA 30188 (US).  (74) Agents: NOTO, Aldo; Dorsey &amp; Whitney, 1330 Connecticut Avenue, N.W., Suite 200, Washington, DC 20036 (US) et al.</p>	<p>(81) Designated States: AT, AU, BB, BG, BR, BY, CA, CH, CZ, DE, DK, ES, FI, GB, HU, JP, KP, KR, KZ, LK, LU, LV, MG, MN, MW, NL, NO, NZ, PL, PT, RO, RU, SD, SE, SK, UA, VN, European patent (AT, BE, CH, DE, DK, ES, FR, GB, GR, IE, IT, LU, MC, NL, PT, SE), OAPI patent (BF, BJ, CF, CG, CI, CM, GA, GN, ML, MR, NE, SN, TD, TG).</p> <p><b>Published</b> <i>With international search report.</i> <i>With amended claims and statement.</i></p> <p><b>Date of publication of the amended claims and statement:</b> 21 July 1994 (21.07.94)</p>	

(54) Title: ADVANCED SET TOP TERMINAL FOR CABLE TELEVISION DELIVERY SYSTEMS

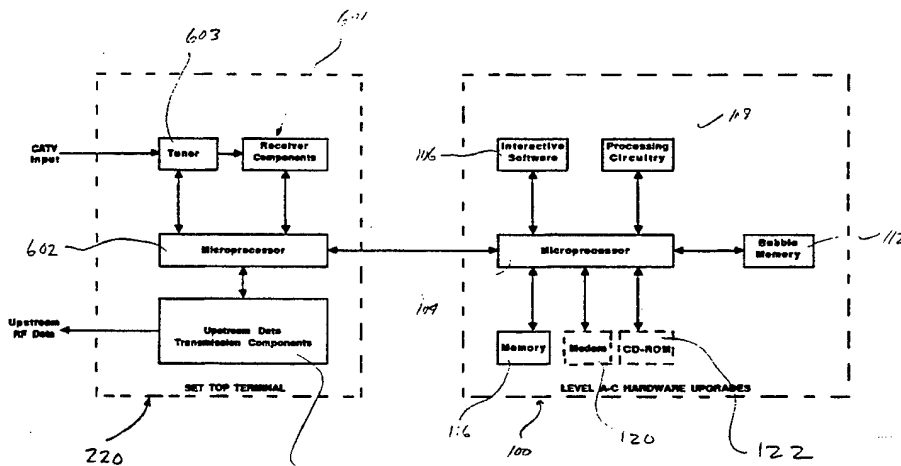

(57) Abstract

A novel advanced set top terminal capable of digital decompression, menu generation, interactivity and other advanced functional capabilities for use in a television program delivery system (200) is described. The invention relates to methods and apparatus for upgrading existing set top terminals (220) to provide menu generation capability and advanced functional capabilities. The invention is particularly useful in television program delivery systems (200) with hundreds of channels of programming, providing (i) menu driven program selection through the addition of an upgrade module (300) or menu generation card and (ii) advanced functional capabilities using a set of hardware upgrades (e.g. 130) and/or an expansion card. Specifically, the invention is an upgradeable system that supports advanced set top functionality through the use of internal software, hardware upgrades, an upgrade module and/or expansion cards. The upgraded hardware generally includes a microprocessor, various input/output ports (e.g., 308), processing circuitry (e.g., 108) and memory (e.g., 116). The invention results in an upgraded set top terminal that supports: menu generation; picture-on-picture displays; program catalogue services; interactive services; telephone caller identification; digital audio reception; VCR control; HDTV reception; and backyard satellite system interoperability, among other features and capabilities.

\* (Referred to in PCT Gazette No. 30/1995, Section II)

**FOR THE PURPOSES OF INFORMATION ONLY**

Codes used to identify States party to the PCT on the front pages of pamphlets publishing international applications under the PCT.

AT	Austria	GB	United Kingdom	MR	Mauritania
AU	Australia	GE	Georgia	MW	Malawi
BB	Barbados	GN	Guinea	NE	Niger
BE	Belgium	GR	Greece	NL	Netherlands
BF	Burkina Faso	HU	Hungary	NO	Norway
BG	Bulgaria	IE	Ireland	NZ	New Zealand
BJ	Benin	IT	Italy	PL	Poland
BR	Brazil	JP	Japan	PT	Portugal
BY	Belarus	KE	Kenya	RO	Romania
CA	Canada	KG	Kyrgyzstan	RU	Russian Federation
CF	Central African Republic	KP	Democratic People's Republic of Korea	SD	Sudan
CG	Congo	KR	Republic of Korea	SE	Sweden
CH	Switzerland	KZ	Kazakhstan	SI	Slovenia
CI	Côte d'Ivoire	LI	Liechtenstein	SK	Slovakia
CM	Cameroon	LK	Sri Lanka	SN	Senegal
CN	China	LU	Luxembourg	TD	Chad
CS	Czechoslovakia	LV	Latvia	TG	Togo
CZ	Czech Republic	MC	Monaco	TJ	Tajikistan
DE	Germany	MD	Republic of Moldova	TT	Trinidad and Tobago
DK	Denmark	MG	Madagascar	UA	Ukraine
ES	Spain	ML	Mali	US	United States of America
FI	Finland	MN	Mongolia	UZ	Uzbekistan
FR	France			VN	Viet Nam
GA	Gabon				